

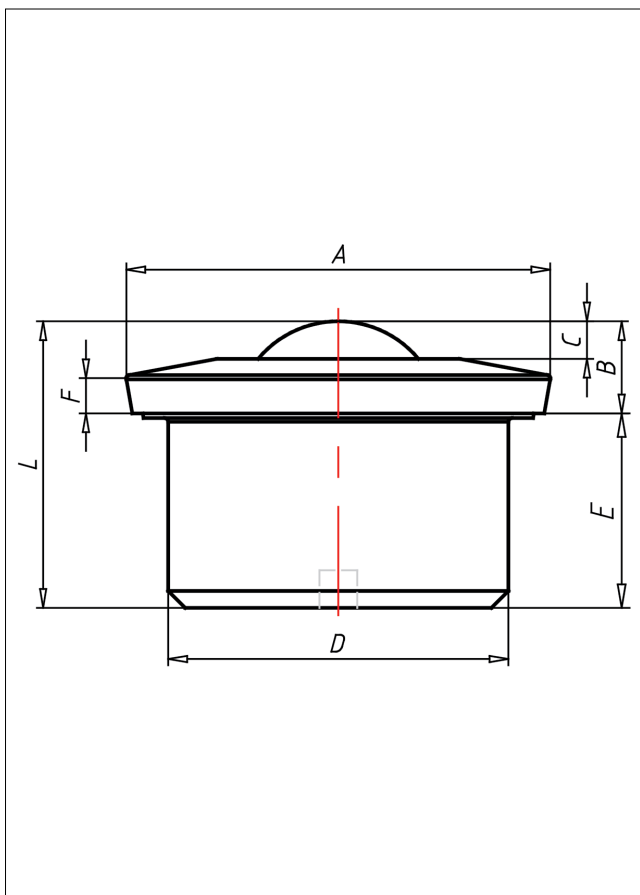

A8

Kugelrollen - Schwerlast



A8 Kugelrollen Schwerlast

+70 °C
-30 °C
max. 4000 kg

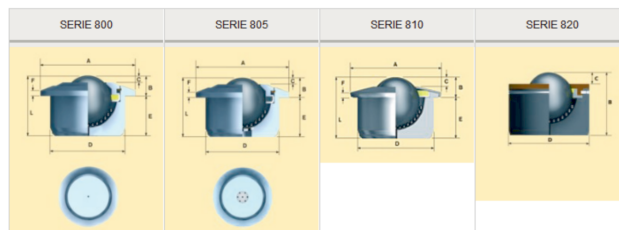

Technische Details

ORDERNO (Artikel-nummer)	A810-30-15
BALL (Kugel-Ø / mm)	30
SER (Serie)	810
FH (Ausführung Gehäuse)	Edelstahl
FB (Ausführung Kugeln)	Edelstahl
LC (Tragkraft / kg)	200
A (/ mm)	55
B (/ mm)	13.8
C (/ mm)	6
D (/ mm)	45
E (/ mm)	23.0
F (/ mm)	5.0