

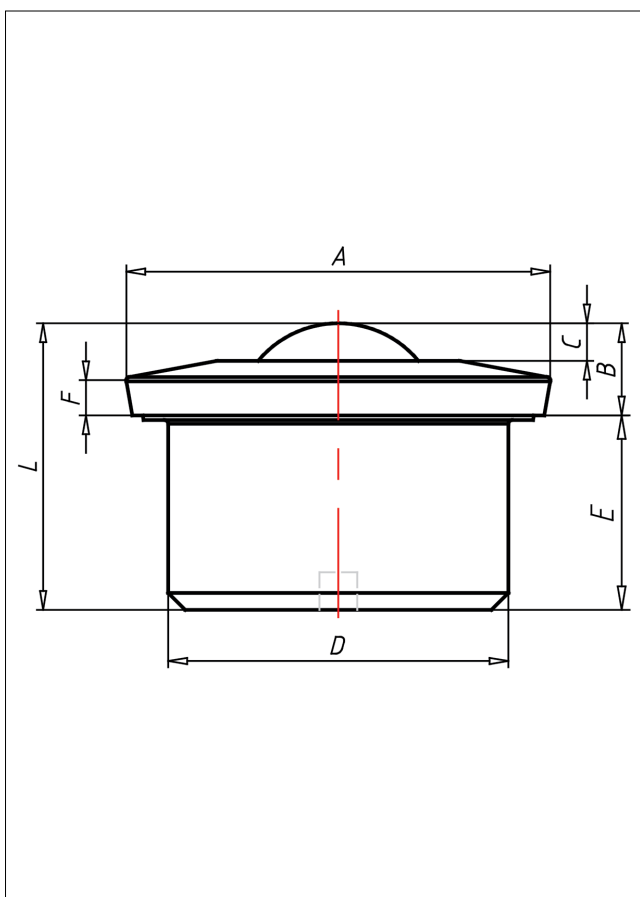

A8

Kugelrollen - Schwerlast



A8 Kugelrollen Schwerlast

+70 °C
-30 °C max.
4000 kg

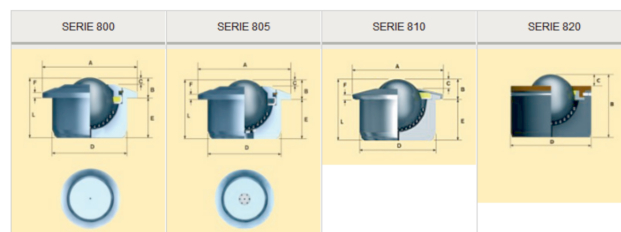

Technische Details

ORDERNO (Artikel-nummer)	A810-45-15
BALL (Kugel-Ø / mm)	45
SER (Serie)	810
FH (Ausführung Gehäuse)	Edelstahl
FB (Ausführung Kugeln)	Edelstahl
LC (Tragkraft / kg)	300
A (/ mm)	75
B (/ mm)	19
C (/ mm)	9
D (/ mm)	62
E (/ mm)	34.5
F (/ mm)	4.5