

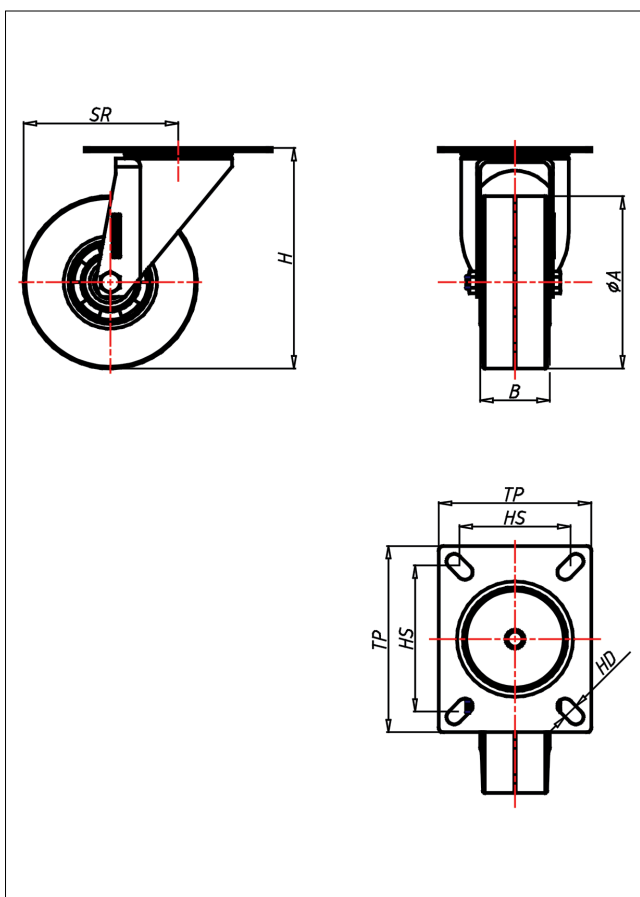

CD/CS/CSS- EK/EB/LEK/LEB Lenkrolle



CD-E



LENKROLLE	LENKROLLE MIT TOTALFESTSTELLER	BOCKROLLE																				
 <ul style="list-style-type: none"> • hoher Fahrkomfort • sehr laufruhig • geringer Rollwiderstand • abriebfest • spurfrei in grau <p>ELASTIK-Vollgummi Felge Spritzguss- Aluminiumlegierung → Seite 259</p> 	 <p>zweifaches Kugellager - vernietet Stahlkugeln gehärtet Dichtungsring, Radachse verschraubt, verzinkt- chrompassiviert</p> <p>→ Seite 62</p>	 <p>AUSWAHLHILFE:</p> <table border="0"> <tr> <td>leicht lenkend</td> <td>+</td> <td>+</td> <td>+</td> </tr> <tr> <td>verschleißarm</td> <td>x</td> <td>x</td> <td>x</td> </tr> <tr> <td>stoßfest</td> <td>+</td> <td>x</td> <td>x</td> </tr> <tr> <td>bodenschonend</td> <td>+</td> <td>x</td> <td>x</td> </tr> <tr> <td>witterungsbeständig</td> <td>x</td> <td>x</td> <td>x</td> </tr> </table>	leicht lenkend	+	+	+	verschleißarm	x	x	x	stoßfest	+	x	x	bodenschonend	+	x	x	witterungsbeständig	x	x	x
leicht lenkend	+	+	+																			
verschleißarm	x	x	x																			
stoßfest	+	x	x																			
bodenschonend	+	x	x																			
witterungsbeständig	x	x	x																			

Technische Details

ORDERNO (Artikel-nummer)	CD 100 EB
WDAB (Rad-Ø A x Breite B / mm)	100x40
LC (Tragkraft / kg)	120
H (Bauhöhe H / mm)	128
TP (Plattengröße / mm)	102x83
HS (Lochabstand / mm)	80x60
HD (Loch-Ø / mm)	9
SR (Schwenkradius / mm)	87
WB (Radlager)	Rollenlager