

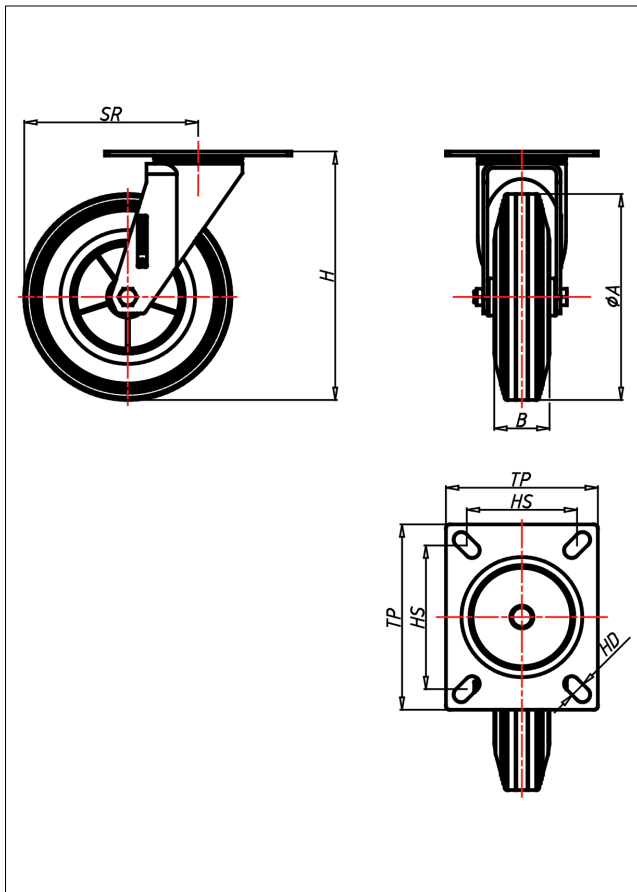

CD/CL-DGB/DG

Lenkrolle



CD-DG



LENKROLLE	LENKROLLE MIT TOTALFESTSTELLER	BOCKROLLE																		
 <ul style="list-style-type: none"> • spurfrei - bodenschonend • hoher Fahrkomfort • sehr laufruhig • geringer Rollwiderstand • abriebfest ELASTIK-Vollgummi Felge Kunststoff → Seite 262	 zweifaches Kugellager - vernietet Stahlkugeln gehärtet Dichtungsring, Radachse verschraubt, verzinkt- chrompassiviert → Seite 62	 AUSWAHLHILFE: <table border="0"> <tr> <td>○</td><td>+</td><td>++</td> </tr> <tr> <td>leicht lenkend</td><td>X</td><td>●</td> </tr> <tr> <td>verschleißarm</td><td>●</td><td>●</td> </tr> <tr> <td>stoßfest</td><td>X</td><td>X</td> </tr> <tr> <td>bodenschonend</td><td>●</td><td>X</td> </tr> <tr> <td>witterungsbeständig</td><td>X</td><td>●</td> </tr> </table>	○	+	++	leicht lenkend	X	●	verschleißarm	●	●	stoßfest	X	X	bodenschonend	●	X	witterungsbeständig	X	●
○	+	++																		
leicht lenkend	X	●																		
verschleißarm	●	●																		
stoßfest	X	X																		
bodenschonend	●	X																		
witterungsbeständig	X	●																		

Technische Details

ORDERNO (Artikel-nummer)	CD 150 DG
WDAB (Rad-Ø A x Breite B / mm)	150x40
LC (Tragkraft / kg)	150
H (Bauhöhe H / mm)	181
TP (Plattengröße / mm)	135x110
HS (Lochabstand / mm)	105x80
HD (Loch-Ø / mm)	11
SR (Schwenkradius / mm)	126
WB (Radlager)	Polyamid-Gleitlager