

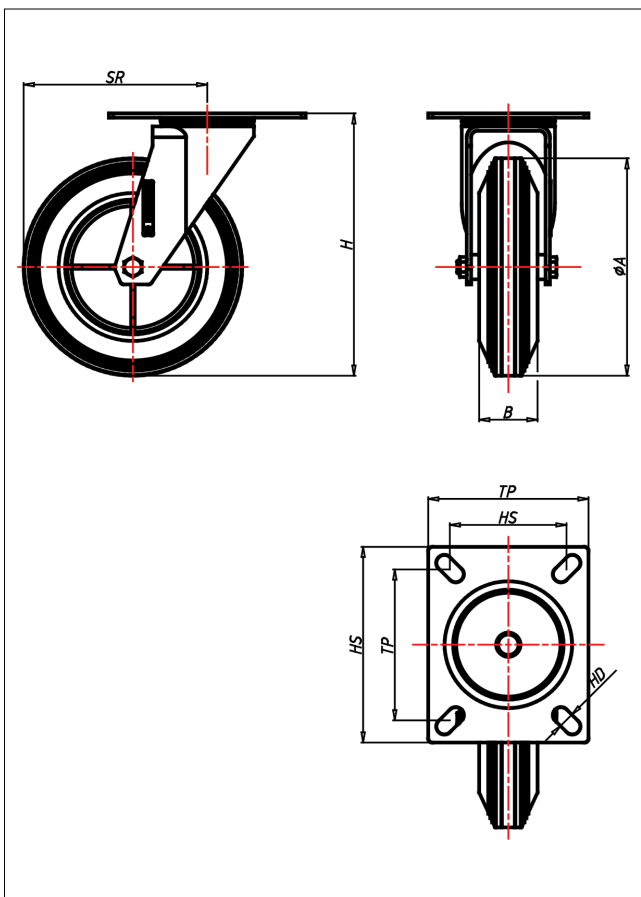

CD/CL-CGB/CGK

Lenkrolle



CD-CG



LENKROLLE	LENKROLLE MIT TOTALFESTSTELLER	BOCKROLLE																									
 <ul style="list-style-type: none"> • spurfrei - bodenschonend • hoher Fahrkomfort • sehr laufruhig • geringer Rollwiderstand • abriebfest <p>ELASTIK-Vollgummi Felge Stahlblech verzinkt → Seite 263</p> 	 <p>zweifaches Kugellager - vernietet Stahlkugeln gehärtet Dichtungsring, Radachse verschraubt, verzinkt- chrompassiviert → Seite 62</p>	 <p>AUSWAHLHILFE:</p> <table border="0"> <tr> <td>leicht lenkend</td> <td>✗</td> <td>✗</td> <td>✗</td> <td>✗</td> </tr> <tr> <td>verschleißarm</td> <td>✗</td> <td>✗</td> <td>✗</td> <td>✗</td> </tr> <tr> <td>stoßfest</td> <td>✗</td> <td>✗</td> <td>✗</td> <td>✗</td> </tr> <tr> <td>bodenschonend</td> <td>✗</td> <td>✗</td> <td>✗</td> <td>✗</td> </tr> <tr> <td>witterungsbeständig</td> <td>✗</td> <td>✗</td> <td>✗</td> <td>✗</td> </tr> </table>	leicht lenkend	✗	✗	✗	✗	verschleißarm	✗	✗	✗	✗	stoßfest	✗	✗	✗	✗	bodenschonend	✗	✗	✗	✗	witterungsbeständig	✗	✗	✗	✗
leicht lenkend	✗	✗	✗	✗																							
verschleißarm	✗	✗	✗	✗																							
stoßfest	✗	✗	✗	✗																							
bodenschonend	✗	✗	✗	✗																							
witterungsbeständig	✗	✗	✗	✗																							

Technische Details

ORDERNO (Artikel-nummer)	CD 160 CGB
WDAB (Rad-Ø A x Breite B / mm)	160x40
LC (Tragkraft / kg)	200
H (Bauhöhe H / mm)	191
TP (Plattengröße / mm)	135x110
HS (Lochabstand / mm)	105x80
HD (Loch-Ø / mm)	11
SR (Schwenkradius / mm)	131
WB (Radlager)	Rollenlager