

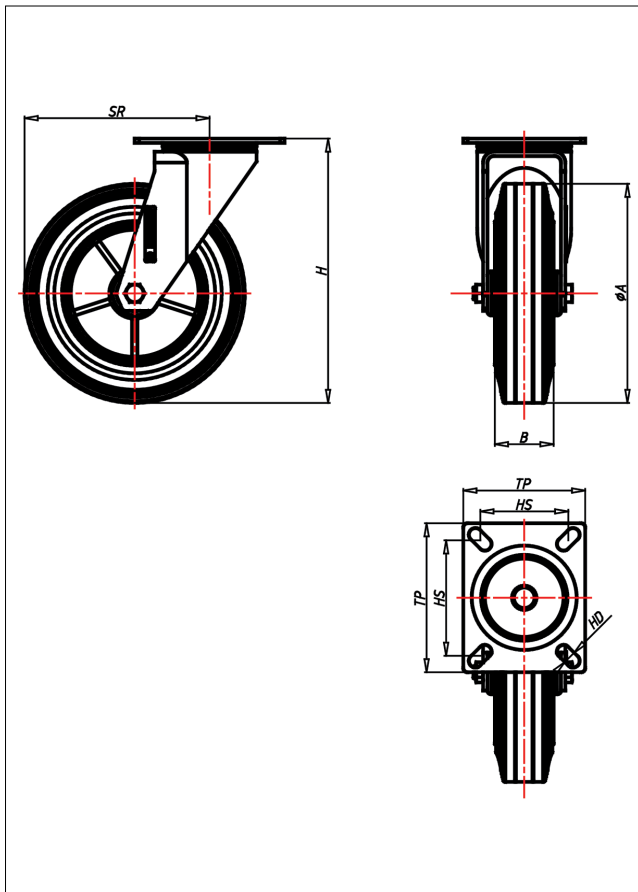

CD/CL-DB/D

Lenkrolle



CD-D



LENKROLLE	LENKROLLE MIT TOTALFESTSTELLER	BOCKROLLE
 <ul style="list-style-type: none"> • geräuscharmer Lauf • großer Fahrkomfort • beständig gegen verdünnte Säuren <p>Vollgummi schwarz Felge Kunststoff schwarz → Seite 265</p> 	 <p>zweifaches Kugellager - vernietet Stahlkugeln gehärtet Dichtungsring, Radachse verschraubt, verzinkt- chrompassiviert → Seite 62</p>	 <p>AUSWAHLHILFE: <input type="radio"/> <input checked="" type="radio"/> <input checked="" type="radio"/></p> <p>leicht lenkend <input checked="" type="radio"/> <input checked="" type="radio"/> <input checked="" type="radio"/></p> <p>verschleißarm <input checked="" type="radio"/> <input checked="" type="radio"/> <input checked="" type="radio"/></p> <p>stoßfest <input checked="" type="radio"/> <input checked="" type="radio"/> <input checked="" type="radio"/></p> <p>bodenschonend <input checked="" type="radio"/> <input checked="" type="radio"/> <input checked="" type="radio"/></p> <p>witterungsbeständig <input checked="" type="radio"/> <input checked="" type="radio"/> <input checked="" type="radio"/></p>

Technische Details

ORDERNO (Artikel-nummer)	CD 200 DB
WDAB (Rad-Ø A x Breite B / mm)	200x50
LC (Tragkraft / kg)	205
H (Bauhöhe H / mm)	240
TP (Plattengröße / mm)	135x110
HS (Lochabstand / mm)	105x80
HD (Loch-Ø / mm)	11
SR (Schwenkradius / mm)	159
WB (Radlager)	Rollenlager