

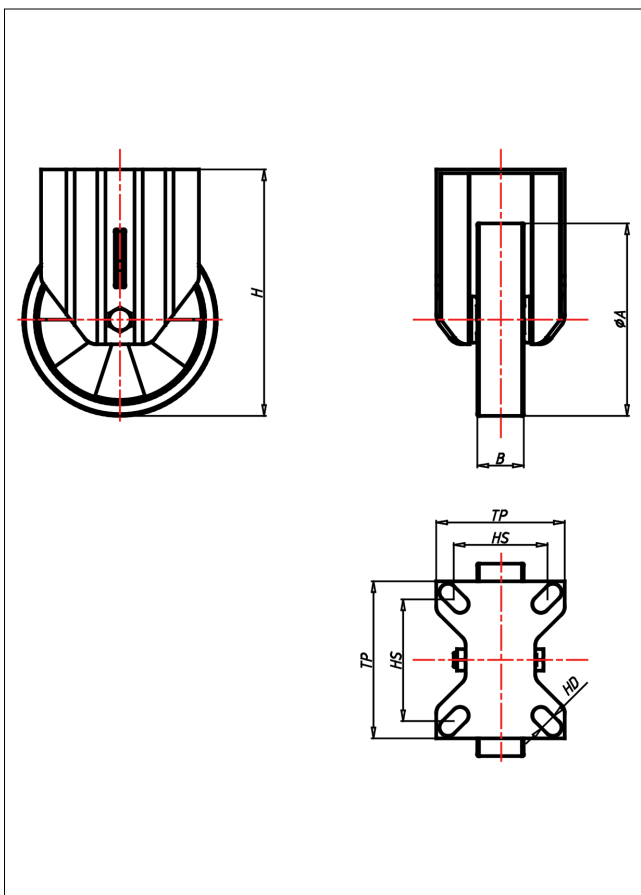

CDF/CSF/CSSF/CLF- TLK/TLB

Bockrolle

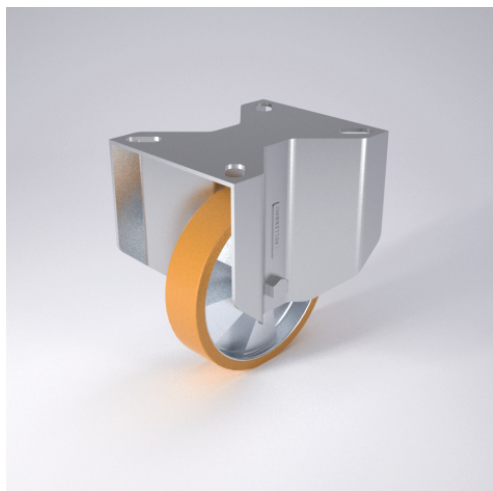

CD-TL



LENKROLLE	LENKROLLE MIT TOTALFESTSTELLER	BOCKROLLE															
<ul style="list-style-type: none"> • geräuscharmer Lauf • geringer Rollwiderstand • abrieb- und reißfest • hohe Stoßfestigkeit • sehr beständig gegen viele aggressive Medien <p>Guss-Polyurethan Felge Spritzguss-Aluminium-Legierung → Seite 250</p>	<p>zweifaches Kugellager - vernietet Stahlkugeln gehärtet Dichtungsring, Radachse verschraubt, verzinkt-chrompassiviert</p> <p>→ Seite 62</p>	<p>AUSWAHLHILFE:</p> <table border="0"> <tr> <td>leicht lenkend</td> <td><input checked="" type="checkbox"/></td> <td><input checked="" type="checkbox"/></td> </tr> <tr> <td>verschleißarm</td> <td><input checked="" type="checkbox"/></td> <td><input checked="" type="checkbox"/></td> </tr> <tr> <td>stoßfest</td> <td><input checked="" type="checkbox"/></td> <td><input checked="" type="checkbox"/></td> </tr> <tr> <td>bodenschonend</td> <td><input checked="" type="checkbox"/></td> <td><input checked="" type="checkbox"/></td> </tr> <tr> <td>witterungsbeständig</td> <td><input checked="" type="checkbox"/></td> <td><input checked="" type="checkbox"/></td> </tr> </table>	leicht lenkend	<input checked="" type="checkbox"/>	<input checked="" type="checkbox"/>	verschleißarm	<input checked="" type="checkbox"/>	<input checked="" type="checkbox"/>	stoßfest	<input checked="" type="checkbox"/>	<input checked="" type="checkbox"/>	bodenschonend	<input checked="" type="checkbox"/>	<input checked="" type="checkbox"/>	witterungsbeständig	<input checked="" type="checkbox"/>	<input checked="" type="checkbox"/>
leicht lenkend	<input checked="" type="checkbox"/>	<input checked="" type="checkbox"/>															
verschleißarm	<input checked="" type="checkbox"/>	<input checked="" type="checkbox"/>															
stoßfest	<input checked="" type="checkbox"/>	<input checked="" type="checkbox"/>															
bodenschonend	<input checked="" type="checkbox"/>	<input checked="" type="checkbox"/>															
witterungsbeständig	<input checked="" type="checkbox"/>	<input checked="" type="checkbox"/>															

Technische Details

ORDERNO (Artikel-nummer)	CDF 100 TLK
WDAB (Rad-Ø A x Breite B / mm)	100x30
LC (Tragkraft / kg)	120
H (Bauhöhe H / mm)	128
TP (Plattengröße / mm)	102x83
HS (Lochabstand / mm)	80x60
HD (Loch-Ø / mm)	9
WB (Radlager)	Kugellager