

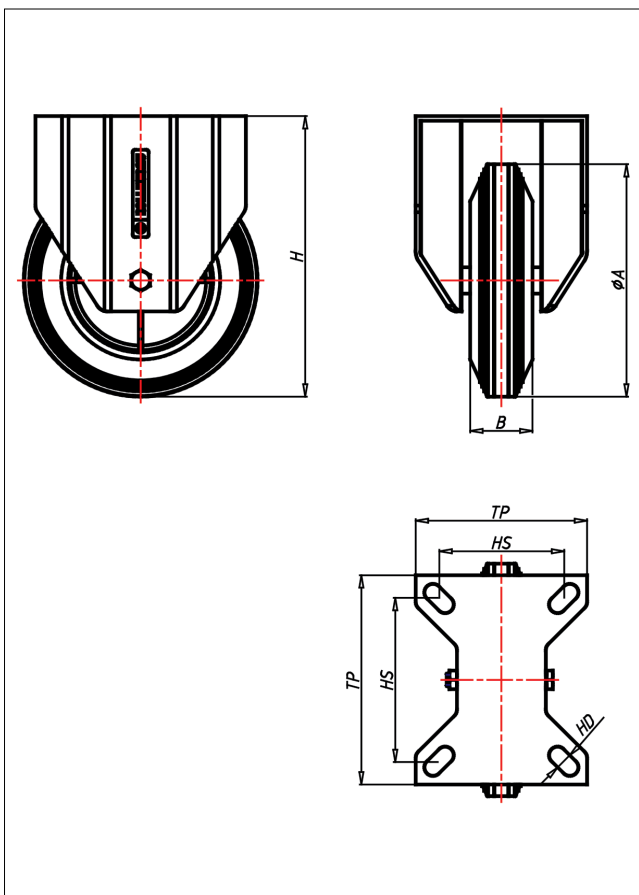

# CDF/CLF-CGB/CGK

Bockrolle

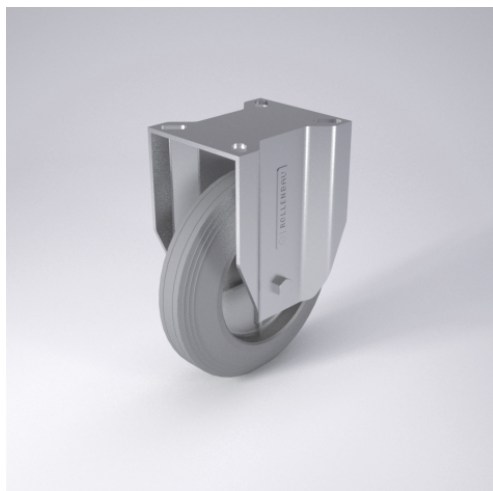

CD-CG



+60 °C  
-20 °C max. 280 kg

LENKROLLE	LENKROLLE MIT TOTALFESTSTELLER	BOCKROLLE
<ul style="list-style-type: none"> <li>• spurfrei - bodenschonend</li> <li>• hoher Fahrkomfort</li> <li>• sehr laufruhig</li> <li>• geringer Rollwiderstand</li> <li>• abriebfest</li> </ul>	<ul style="list-style-type: none"> <li>• zweifaches Kugellager - vernietet</li> <li>• Stahlkugeln gehärtet</li> <li>• Dichtungsring, Radachse verschraubt, verzinkt-chrompassiviert</li> </ul>	<p>AUSWAHLHILFE:</p> <ul style="list-style-type: none"> <li>leicht lenkend</li> <li>verschleißarm</li> <li>stoßfest</li> <li>bodenschonend</li> <li>witterungsbeständig</li> </ul>
<p>ELASTIK-Vollgummi Felge Stahlblech verzinkt → Seite 263</p>	<p>→ Seite 62</p>	

## Technische Details

ORDERNO (Artikel-nummer)	CDF 150 CGK
WDAB (Rad-Ø A x Breite B / mm)	150x40
LC (Tragkraft / kg)	200
H (Bauhöhe H / mm)	181
TP (Plattengröße / mm)	135x110
HS (Lochabstand / mm)	105x80
HD (Loch-Ø / mm)	11
WB (Radlager)	Kugellager