

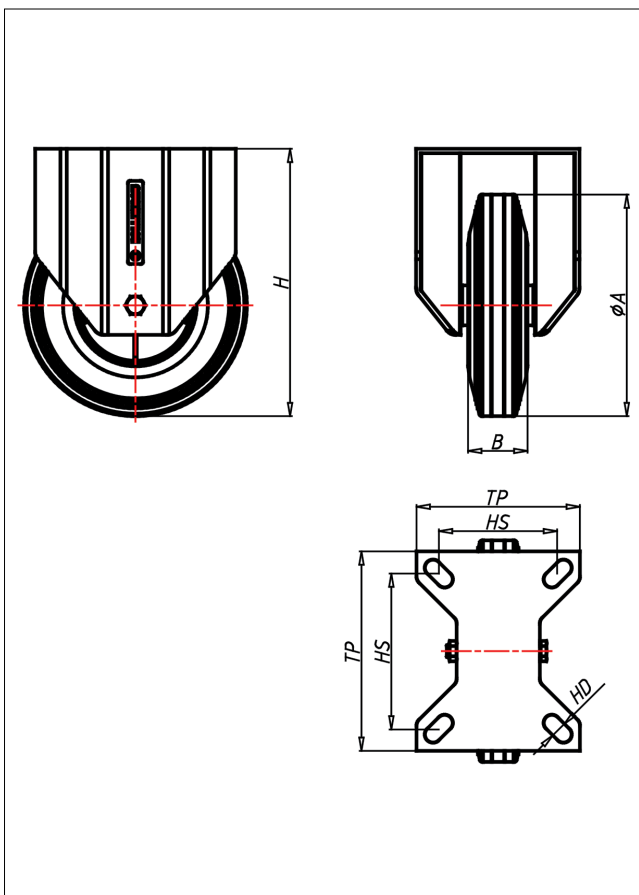

# CDF/CLF-DGB/DG

## Bockrolle

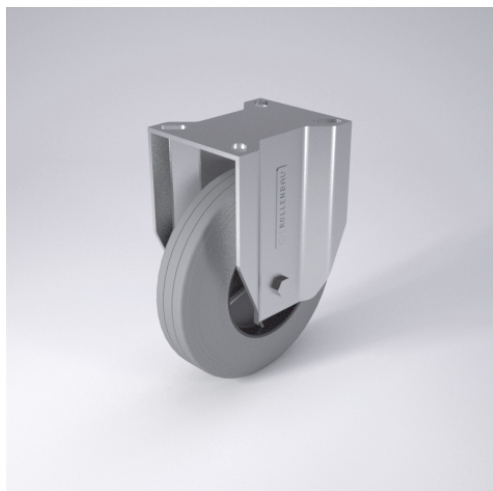

### CD-DG



LENKROLLE	LENKROLLE MIT TOTALFESTSTELLER	BOCKROLLE																				
<ul style="list-style-type: none"> <li>• spurfrei - bodenschonend</li> <li>• hoher Fahrkomfort</li> <li>• sehr laufruhig</li> <li>• geringer Rollwiderstand</li> <li>• abriebfest</li> </ul> ELASTIK-Vollgummi Felge Kunststoff → Seite 262	 zweifaches Kugellager - vernietet Stahlkugeln gehärtet Dichtungsring, Radachse verschraubt, verzinkt- chrompassiviert → Seite 62	AUSWAHLHILFE: <table border="0"> <tr> <td>leicht lenkend</td> <td><input checked="" type="checkbox"/></td> <td><input type="checkbox"/></td> <td><input type="checkbox"/></td> </tr> <tr> <td>verschleißarm</td> <td><input type="checkbox"/></td> <td><input checked="" type="checkbox"/></td> <td><input type="checkbox"/></td> </tr> <tr> <td>stoßfest</td> <td><input type="checkbox"/></td> <td><input checked="" type="checkbox"/></td> <td><input type="checkbox"/></td> </tr> <tr> <td>bodenschonend</td> <td><input type="checkbox"/></td> <td><input checked="" type="checkbox"/></td> <td><input type="checkbox"/></td> </tr> <tr> <td>witterungsbeständig</td> <td><input checked="" type="checkbox"/></td> <td><input type="checkbox"/></td> <td><input type="checkbox"/></td> </tr> </table>	leicht lenkend	<input checked="" type="checkbox"/>	<input type="checkbox"/>	<input type="checkbox"/>	verschleißarm	<input type="checkbox"/>	<input checked="" type="checkbox"/>	<input type="checkbox"/>	stoßfest	<input type="checkbox"/>	<input checked="" type="checkbox"/>	<input type="checkbox"/>	bodenschonend	<input type="checkbox"/>	<input checked="" type="checkbox"/>	<input type="checkbox"/>	witterungsbeständig	<input checked="" type="checkbox"/>	<input type="checkbox"/>	<input type="checkbox"/>
leicht lenkend	<input checked="" type="checkbox"/>	<input type="checkbox"/>	<input type="checkbox"/>																			
verschleißarm	<input type="checkbox"/>	<input checked="" type="checkbox"/>	<input type="checkbox"/>																			
stoßfest	<input type="checkbox"/>	<input checked="" type="checkbox"/>	<input type="checkbox"/>																			
bodenschonend	<input type="checkbox"/>	<input checked="" type="checkbox"/>	<input type="checkbox"/>																			
witterungsbeständig	<input checked="" type="checkbox"/>	<input type="checkbox"/>	<input type="checkbox"/>																			

### Technische Details

ORDERNO (Artikel-nummer)	CDF 160 DG
WDAB (Rad-Ø A x Breite B / mm)	160x40
LC (Tragkraft / kg)	160
H (Bauhöhe H / mm)	191
TP (Plattengröße / mm)	135x110
HS (Lochabstand / mm)	105x80
HD (Loch-Ø / mm)	11
WB (Radlager)	Polyamid-Gleitlager