

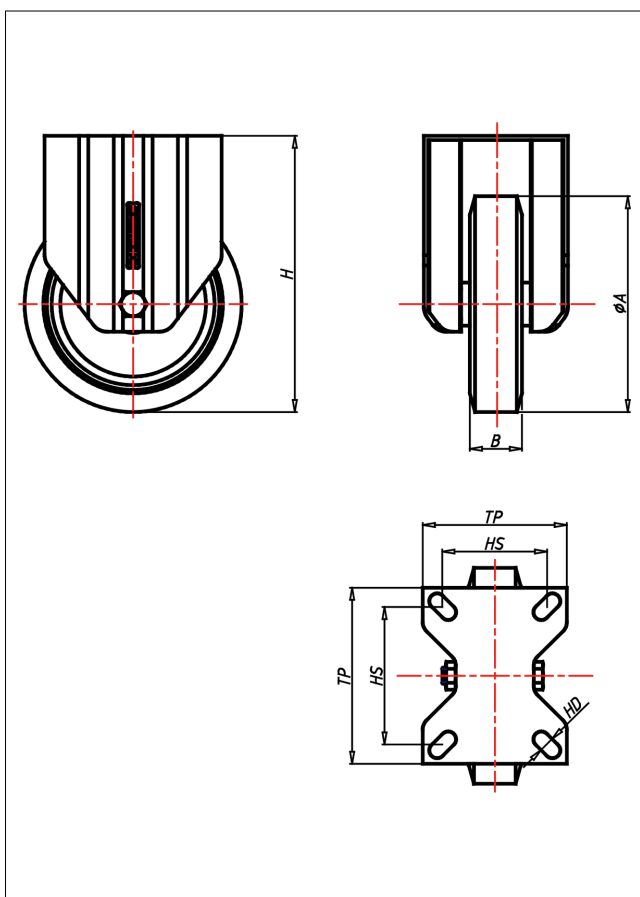

# CDF/CSF/CSSF/CLF- A/AK/AB

## Bockrolle



CD-A



LENKROLLE	LENKROLLE MIT TOTALFESTSTELLER	BOCKROLLE																				
 <ul style="list-style-type: none"> <li>• geräuscharmer Lauf</li> <li>• geringer Rollwiderstand</li> <li>• abrieb- und reißfest</li> <li>• hohe Stoßfestigkeit</li> <li>• leichte Reinigung</li> <li>• sehr beständig gegen viele aggressive Medien</li> </ul> <p>Guss-Polyurethan Felge Polyamid 6 → Seite 252</p> 	 <p>zweifaches Kugellager - vernietet Stahlkugeln gehärtet Dichtungsring, Radachse verschraubt, verzinkt- chrompassiviert</p> <p>→ Seite 62</p>	 <p>AUSWAHLHILFE:</p> <table border="0"> <tr> <td>leicht lenkend</td> <td>-</td> <td>+</td> <td>++</td> </tr> <tr> <td>verschleißarm</td> <td>x</td> <td>x</td> <td>x</td> </tr> <tr> <td>stoßfest</td> <td>x</td> <td>x</td> <td>x</td> </tr> <tr> <td>bodenschonend</td> <td>x</td> <td>x</td> <td>x</td> </tr> <tr> <td>witterungsbeständig</td> <td>x</td> <td>x</td> <td>x</td> </tr> </table>	leicht lenkend	-	+	++	verschleißarm	x	x	x	stoßfest	x	x	x	bodenschonend	x	x	x	witterungsbeständig	x	x	x
leicht lenkend	-	+	++																			
verschleißarm	x	x	x																			
stoßfest	x	x	x																			
bodenschonend	x	x	x																			
witterungsbeständig	x	x	x																			

### Technische Details

<b>ORDERNO (Artikel-nummer)</b>	CDF 200 A
<b>WDAB (Rad-Ø A x Breite B / mm)</b>	200x50
<b>LC (Tragkraft / kg)</b>	300
<b>H (Bauhöhe H / mm)</b>	240
<b>TP (Plattengröße / mm)</b>	135x110
<b>HS (Lochabstand / mm)</b>	105x80
<b>HD (Loch-Ø / mm)</b>	11
<b>WB (Radlager)</b>	Nylon plain bearing