

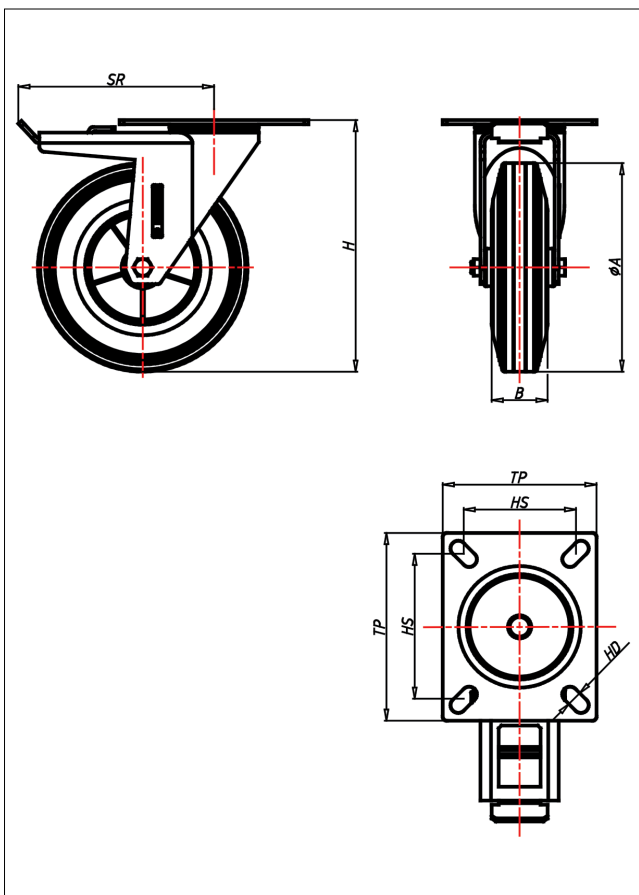

CDT/CLT-DGB/DG

Lenkrolle mit Totalfeststeller



CD-DG



LENKROLLE	LENKROLLE MIT TOTALFESTSTELLER	BOCKROLLE																				
<ul style="list-style-type: none"> • spurfrei - bodenschonend • hoher Fahrkomfort • sehr laufruhig • geringer Rollwiderstand • abriebfest <p>ELASTIK-Vollgummi Felge Kunststoff → Seite 262</p>	<p>zweifaches Kugellager - vernietet Stahlkugeln gehärtet</p> <p>Dichtungsring, Radachse verschraubt, verzinkt- chrompassiviert</p> <p>→ Seite 62</p>	<p>AUSWAHLHILFE:</p> <table border="0"> <tr> <td>leicht lenkend</td> <td><input checked="" type="checkbox"/></td> <td><input type="checkbox"/></td> <td><input type="checkbox"/></td> </tr> <tr> <td>verschleißarm</td> <td><input checked="" type="checkbox"/></td> <td><input type="checkbox"/></td> <td><input type="checkbox"/></td> </tr> <tr> <td>stoßfest</td> <td><input checked="" type="checkbox"/></td> <td><input type="checkbox"/></td> <td><input type="checkbox"/></td> </tr> <tr> <td>bodenschonend</td> <td><input checked="" type="checkbox"/></td> <td><input type="checkbox"/></td> <td><input type="checkbox"/></td> </tr> <tr> <td>witterungsbeständig</td> <td><input checked="" type="checkbox"/></td> <td><input type="checkbox"/></td> <td><input type="checkbox"/></td> </tr> </table>	leicht lenkend	<input checked="" type="checkbox"/>	<input type="checkbox"/>	<input type="checkbox"/>	verschleißarm	<input checked="" type="checkbox"/>	<input type="checkbox"/>	<input type="checkbox"/>	stoßfest	<input checked="" type="checkbox"/>	<input type="checkbox"/>	<input type="checkbox"/>	bodenschonend	<input checked="" type="checkbox"/>	<input type="checkbox"/>	<input type="checkbox"/>	witterungsbeständig	<input checked="" type="checkbox"/>	<input type="checkbox"/>	<input type="checkbox"/>
leicht lenkend	<input checked="" type="checkbox"/>	<input type="checkbox"/>	<input type="checkbox"/>																			
verschleißarm	<input checked="" type="checkbox"/>	<input type="checkbox"/>	<input type="checkbox"/>																			
stoßfest	<input checked="" type="checkbox"/>	<input type="checkbox"/>	<input type="checkbox"/>																			
bodenschonend	<input checked="" type="checkbox"/>	<input type="checkbox"/>	<input type="checkbox"/>																			
witterungsbeständig	<input checked="" type="checkbox"/>	<input type="checkbox"/>	<input type="checkbox"/>																			

Technische Details

ORDERNO (Artikel-nummer)	CDT 100 DGB
WDAB (Rad-Ø A x Breite B / mm)	100x30
LC (Tragkraft / kg)	85
H (Bauhöhe H / mm)	128
TP (Plattengröße / mm)	102x83
HS (Lochabstand / mm)	80x60
HD (Loch-Ø / mm)	9
SR (Schwenkradius / mm)	108
WB (Radlager)	Rollenlager