

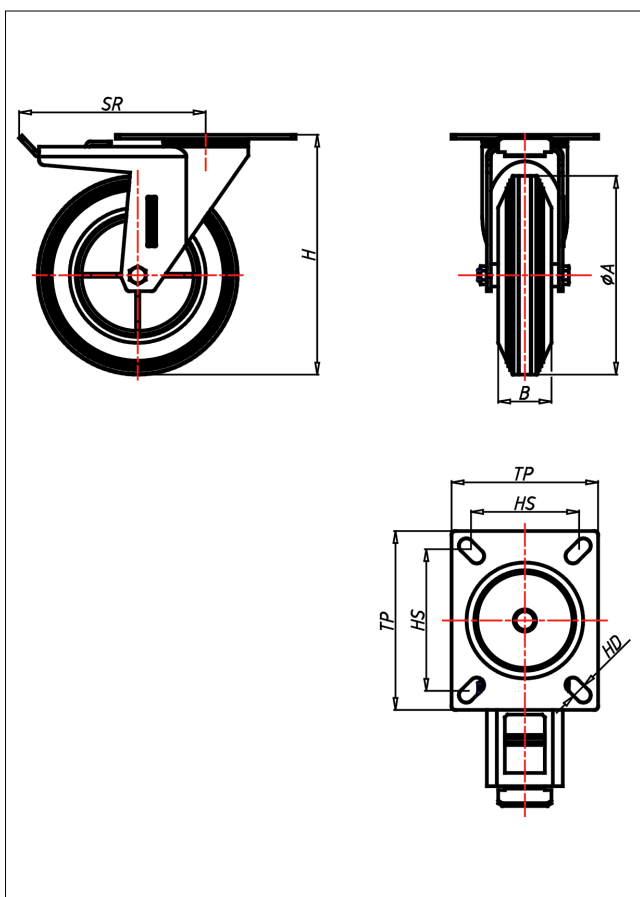

CDT/CLT-CGB/CGK

Lenkrolle mit Totalfeststeller



CD-CG



LENKROLLE	LENKROLLE MIT TOTALFESTSTELLER	BOCKROLLE
<ul style="list-style-type: none"> • spurfrei - bodenschonend • hoher Fahrkomfort • sehr laufruhig • geringer Rollwiderstand • abriebfest 	<ul style="list-style-type: none"> • zweifaches Kugellager - vernietet • Stahlkugeln gehärtet • Dichtungsring, Radachse verschraubt, verzinkt-chrompassiviert 	<p>AUSWAHLHILFE:</p> <ul style="list-style-type: none"> leicht lenkend verschleißarm stoßfest bodenschonend witterungsbeständig
<p>ELASTIK-Vollgummi Felge Stahlblech verzinkt → Seite 263</p>	<p>→ Seite 62</p>	

Technische Details

ORDERNO (Artikel-nummer)	CDT 125 CGB
WDAB (Rad-Ø A x Breite B / mm)	125x38
LC (Tragkraft / kg)	12
H (Bauhöhe H / mm)	154
TP (Plattengröße / mm)	102x83
HS (Lochabstand / mm)	80x60
HD (Loch-Ø / mm)	9
SR (Schwenkradius / mm)	108
WB (Radlager)	Rollenlager