

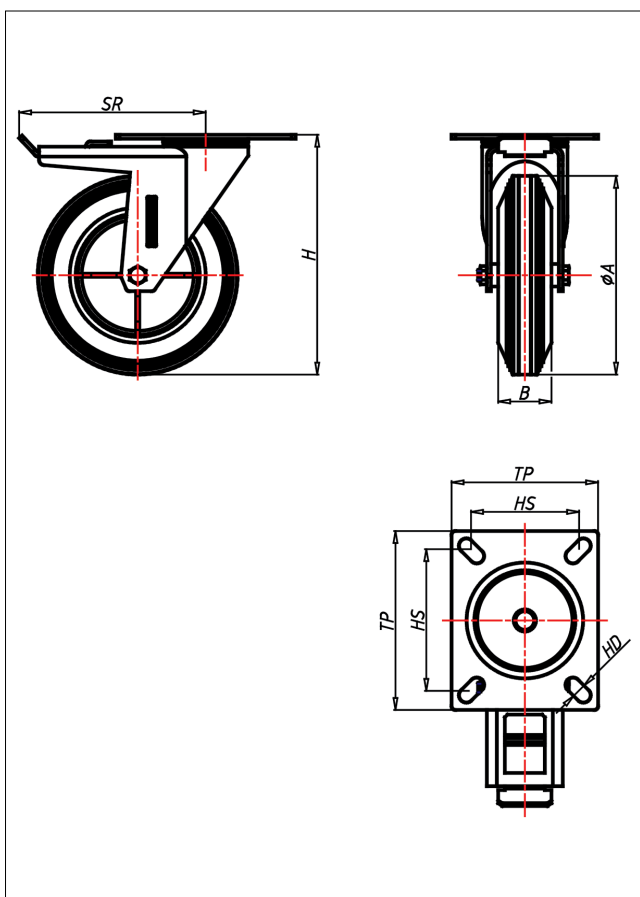

# CDT/CLT-CGB/CGK

## Lenkrolle mit Totalfeststeller



CD-CG



LENKROLLE	LENKROLLE MIT TOTALFESTSTELLER	BOCKROLLE																									
<ul style="list-style-type: none"> <li>• spurfrei - bodenschonend</li> <li>• hoher Fahrkomfort</li> <li>• sehr laufruhig</li> <li>• geringer Rollwiderstand</li> <li>• abriebfest</li> </ul> <p>ELASTIK-Vollgummi Felge Stahlblech verzinkt → Seite 263</p>	<p>zweifaches Kugellager - vernietet Stahlkugeln gehärtet Dichtungsring, Radachse verschraubt, verzinkt- chrompassiviert → Seite 62</p>	<p>AUSWAHLHILFE:</p> <table border="0"> <tr> <td>leicht lenkend</td> <td>✗</td> <td>✗</td> <td>✗</td> <td>✗</td> </tr> <tr> <td>verschleißarm</td> <td>✗</td> <td>✗</td> <td>✗</td> <td>✗</td> </tr> <tr> <td>stoßfest</td> <td>✗</td> <td>✗</td> <td>✗</td> <td>✗</td> </tr> <tr> <td>bodenschonend</td> <td>✗</td> <td>✗</td> <td>✗</td> <td>✗</td> </tr> <tr> <td>witterungsbeständig</td> <td>✗</td> <td>✗</td> <td>✗</td> <td>✗</td> </tr> </table>	leicht lenkend	✗	✗	✗	✗	verschleißarm	✗	✗	✗	✗	stoßfest	✗	✗	✗	✗	bodenschonend	✗	✗	✗	✗	witterungsbeständig	✗	✗	✗	✗
leicht lenkend	✗	✗	✗	✗																							
verschleißarm	✗	✗	✗	✗																							
stoßfest	✗	✗	✗	✗																							
bodenschonend	✗	✗	✗	✗																							
witterungsbeständig	✗	✗	✗	✗																							

### Technische Details

ORDERNO (Artikel-nummer)	CDT 150 CGK
WDAB (Rad-Ø A x Breite B / mm)	150x40
LC (Tragkraft / kg)	200
H (Bauhöhe H / mm)	181
TP (Plattengröße / mm)	135x110
HS (Lochabstand / mm)	105x80
HD (Loch-Ø / mm)	11
SR (Schwenkradius / mm)	140
WB (Radlager)	Kugellager