

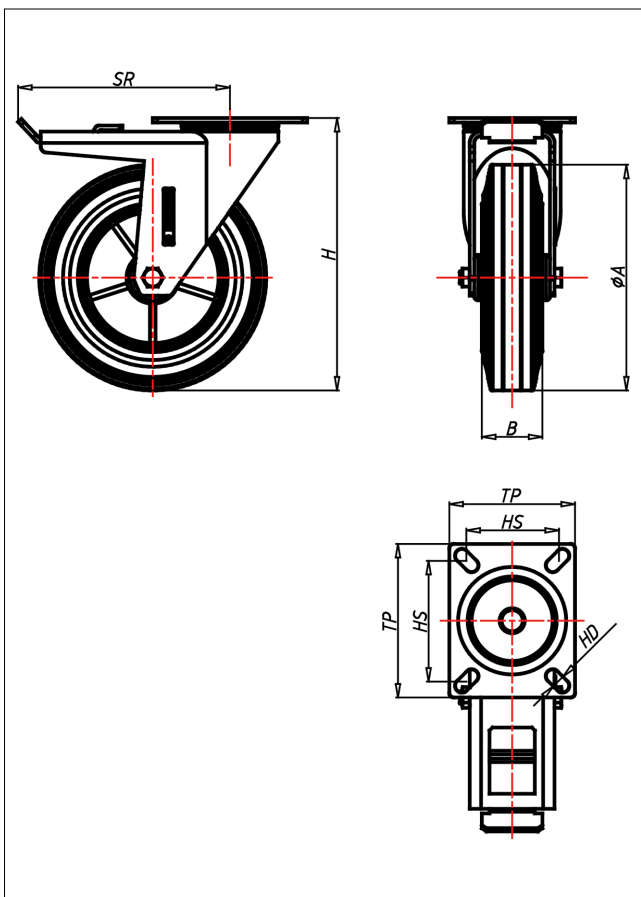

CDT/CLT-DB/D

Lenkrolle mit Totalfeststeller



CD-D



LENKROLLE	LENKROLLE MIT TOTALFESTSTELLER	BOCKROLLE																				
<ul style="list-style-type: none"> geräuscharmer Lauf großer Fahrkomfort beständig gegen verdünnte Säuren Vollgummi schwarz Felge Kunststoff schwarz → Seite 265	<ul style="list-style-type: none"> zweifaches Kugellager - vernietet Stahlkugeln gehärtet Dichtungsring, Radachse verschraubt, verzinkt-chrompassiviert → Seite 62	AUSWAHLHILFE: <table border="0"> <tr> <td>leicht lenkend</td> <td><input checked="" type="checkbox"/></td> <td><input type="checkbox"/></td> <td><input type="checkbox"/></td> </tr> <tr> <td>verschleißarm</td> <td><input checked="" type="checkbox"/></td> <td><input type="checkbox"/></td> <td><input type="checkbox"/></td> </tr> <tr> <td>stoßfest</td> <td><input checked="" type="checkbox"/></td> <td><input type="checkbox"/></td> <td><input type="checkbox"/></td> </tr> <tr> <td>bodenschonend</td> <td><input checked="" type="checkbox"/></td> <td><input type="checkbox"/></td> <td><input type="checkbox"/></td> </tr> <tr> <td>witterungsbeständig</td> <td><input checked="" type="checkbox"/></td> <td><input type="checkbox"/></td> <td><input type="checkbox"/></td> </tr> </table>	leicht lenkend	<input checked="" type="checkbox"/>	<input type="checkbox"/>	<input type="checkbox"/>	verschleißarm	<input checked="" type="checkbox"/>	<input type="checkbox"/>	<input type="checkbox"/>	stoßfest	<input checked="" type="checkbox"/>	<input type="checkbox"/>	<input type="checkbox"/>	bodenschonend	<input checked="" type="checkbox"/>	<input type="checkbox"/>	<input type="checkbox"/>	witterungsbeständig	<input checked="" type="checkbox"/>	<input type="checkbox"/>	<input type="checkbox"/>
leicht lenkend	<input checked="" type="checkbox"/>	<input type="checkbox"/>	<input type="checkbox"/>																			
verschleißarm	<input checked="" type="checkbox"/>	<input type="checkbox"/>	<input type="checkbox"/>																			
stoßfest	<input checked="" type="checkbox"/>	<input type="checkbox"/>	<input type="checkbox"/>																			
bodenschonend	<input checked="" type="checkbox"/>	<input type="checkbox"/>	<input type="checkbox"/>																			
witterungsbeständig	<input checked="" type="checkbox"/>	<input type="checkbox"/>	<input type="checkbox"/>																			

Technische Details

ORDERNO (Artikel-nummer)	CDT 160 D
WDAB (Rad- ϕ A x Breite B / mm)	160x40
LC (Tragkraft / kg)	135
H (Bauhöhe H / mm)	191
TP (Plattengröße / mm)	135x110
HS (Lochabstand / mm)	105x80
HD (Loch- ϕ / mm)	11
SR (Schwenkradius / mm)	140
WB (Radlager)	Polyamid-Gleitlager