

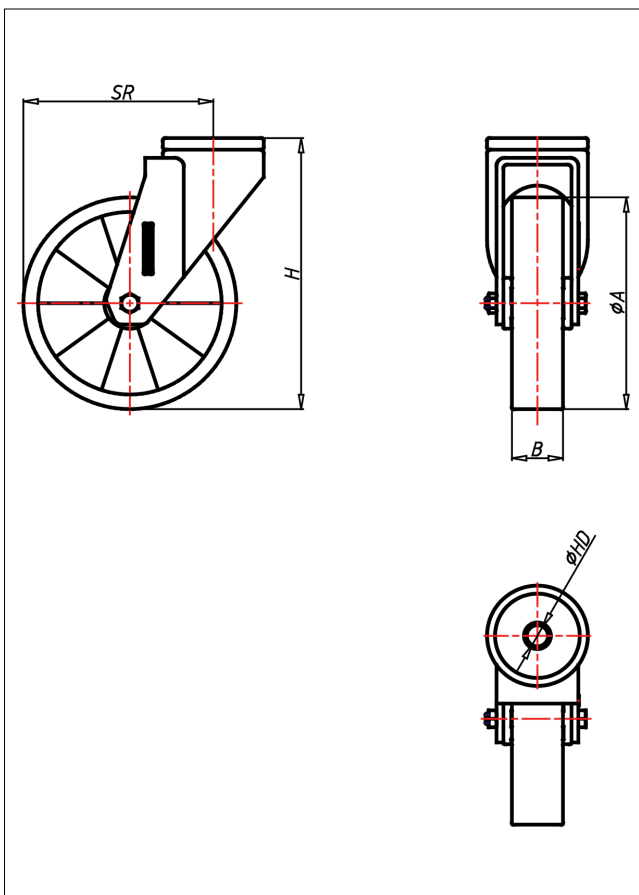

CR/CRS-TLK/TLB

Lenkrolle



CR-TL



LENKROLLE	LENKROLLE MIT TOTALFESTSTELLER																					
<ul style="list-style-type: none"> geräuscharmer Lauf geringer Rollwiderstand abrieb- und reißfest hohe Stoßfestigkeit sehr beständig gegen viele aggressive Medien <p>Guss-Polyurethan Felge Spritzguss-Aluminium-Legierung → Seite 250</p>	<p>zweifaches Kugellager - vernietet Stahlkugeln gehärtet Radachse verschraubt, verzinkt</p> <p>→ Seite 62</p>	<p>AUSWAHLHILFE:</p> <table border="1"> <tr> <td>leicht lenkend</td> <td>-</td> <td>+</td> <td>+</td> </tr> <tr> <td>verschleißarm</td> <td>×</td> <td>×</td> <td>×</td> </tr> <tr> <td>stoßfest</td> <td>×</td> <td>×</td> <td>×</td> </tr> <tr> <td>bodenschonend</td> <td>×</td> <td>×</td> <td>×</td> </tr> <tr> <td>witterungsbeständig</td> <td>×</td> <td>×</td> <td>×</td> </tr> </table>	leicht lenkend	-	+	+	verschleißarm	×	×	×	stoßfest	×	×	×	bodenschonend	×	×	×	witterungsbeständig	×	×	×
leicht lenkend	-	+	+																			
verschleißarm	×	×	×																			
stoßfest	×	×	×																			
bodenschonend	×	×	×																			
witterungsbeständig	×	×	×																			

Technische Details

ORDERNO (Artikel-nummer)	CR 125 TLB
WDAB (Rad-Ø A x Breite B / mm)	125x30
LC (Tragkraft / kg)	120
H (Bauhöhe H / mm)	154
HD (Loch-Ø / mm)	12.5
SR (Schwenkradius / mm)	102.5
WB (Radlager)	Rollenlager