

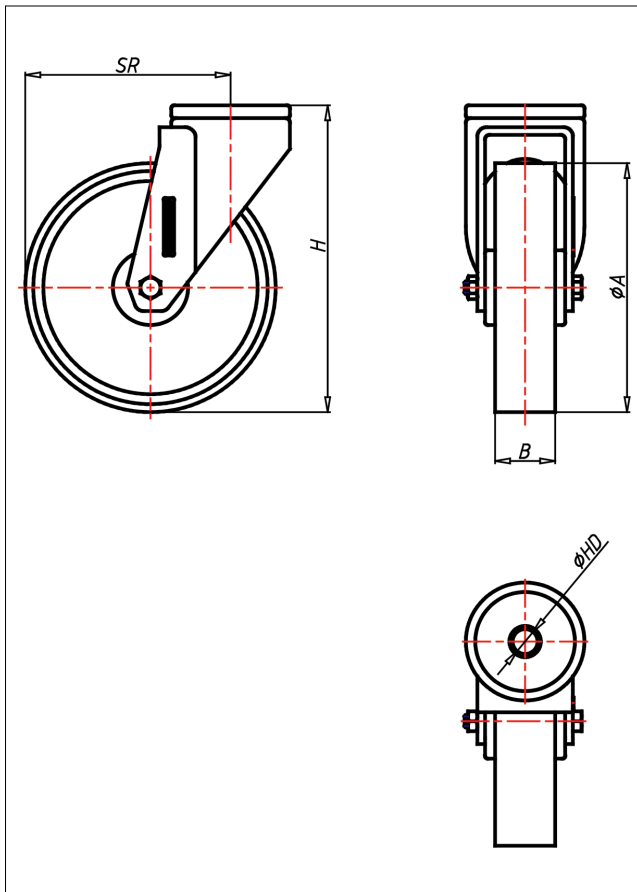

CR/CRS-AL/ALB/ALK

Lenkrolle



CR-AL



LENKROLLE	LENKROLLE MIT TOTALFESTSTELLER	
		
<ul style="list-style-type: none"> • geringer Rollwiderstand • abrieb- und reißfest • leichte Reinigung • sehr beständig gegen viele aggressive Medien Spritzguss-Polyurethan Felge Polyamid 6 → Seite 253	 zweifaches Kugellager - vernietet Stahlkugeln gehärtet Radachse verschraubt, verzinkt → Seite 62	AUSWAHLHILFE: <ul style="list-style-type: none"> leicht lenkend <input checked="" type="checkbox"/> verschleißarm <input checked="" type="checkbox"/> stoßfest <input checked="" type="checkbox"/> bodenschonend <input checked="" type="checkbox"/> witterungsbeständig <input checked="" type="checkbox"/>

Technische Details

ORDERNO (Artikel-nummer)	CR 150 ALB
WDAB (Rad-Ø A x Breite B / mm)	150x40
LC (Tragkraft / kg)	200
H (Bauhöhe H / mm)	181
HD (Loch-Ø / mm)	12.5
SR (Schwenkradius / mm)	126
WB (Radlager)	Rollenlager