

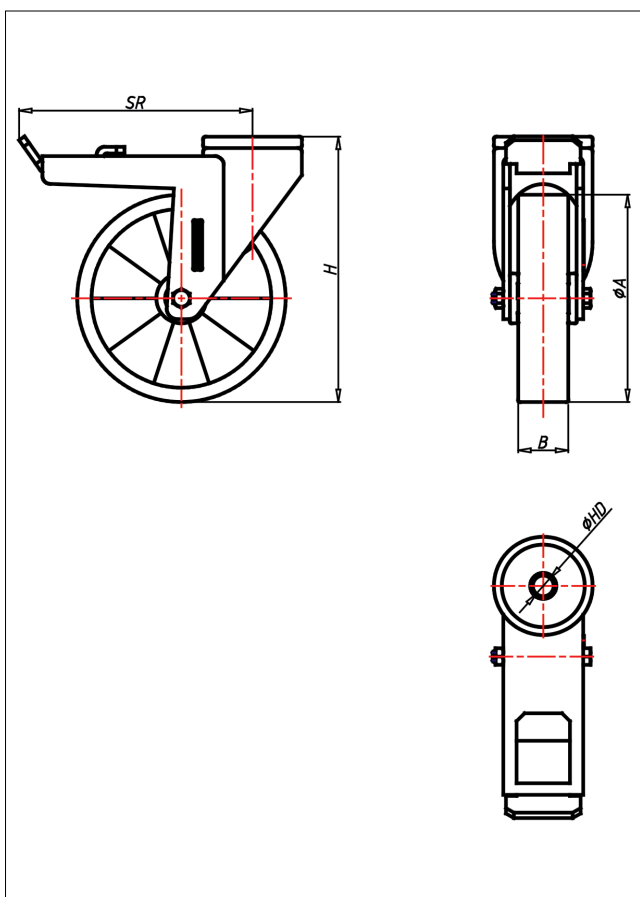

CRT/CRST-TLK/TLB

Lenkrolle mit Totalfeststeller



CR-TL



LENKROLLE	LENKROLLE MIT TOTALFESTSTELLER																					
<ul style="list-style-type: none"> geräuscharmer Lauf geringer Rollwiderstand abrieb- und reißfest hohe Stoßfestigkeit sehr beständig gegen viele aggressive Medien <p>Guss-Polyurethan Felge Spritzguss-Aluminium-Legierung → Seite 250</p>	<p>zweifaches Kugellager - vernietet Stahlkugeln gehärtet Radachse verschraubt, verzinkt</p> <p>→ Seite 62</p>	<p>AUSWAHLHILFE:</p> <table border="0"> <tr> <td>leicht lenkend</td> <td><input type="checkbox"/></td> <td><input checked="" type="checkbox"/></td> <td><input checked="" type="checkbox"/></td> </tr> <tr> <td>verschleißarm</td> <td><input type="checkbox"/></td> <td><input checked="" type="checkbox"/></td> <td><input checked="" type="checkbox"/></td> </tr> <tr> <td>stoßfest</td> <td><input type="checkbox"/></td> <td><input checked="" type="checkbox"/></td> <td><input checked="" type="checkbox"/></td> </tr> <tr> <td>bodenschonend</td> <td><input type="checkbox"/></td> <td><input checked="" type="checkbox"/></td> <td><input checked="" type="checkbox"/></td> </tr> <tr> <td>witterungsbeständig</td> <td><input type="checkbox"/></td> <td><input checked="" type="checkbox"/></td> <td><input checked="" type="checkbox"/></td> </tr> </table>	leicht lenkend	<input type="checkbox"/>	<input checked="" type="checkbox"/>	<input checked="" type="checkbox"/>	verschleißarm	<input type="checkbox"/>	<input checked="" type="checkbox"/>	<input checked="" type="checkbox"/>	stoßfest	<input type="checkbox"/>	<input checked="" type="checkbox"/>	<input checked="" type="checkbox"/>	bodenschonend	<input type="checkbox"/>	<input checked="" type="checkbox"/>	<input checked="" type="checkbox"/>	witterungsbeständig	<input type="checkbox"/>	<input checked="" type="checkbox"/>	<input checked="" type="checkbox"/>
leicht lenkend	<input type="checkbox"/>	<input checked="" type="checkbox"/>	<input checked="" type="checkbox"/>																			
verschleißarm	<input type="checkbox"/>	<input checked="" type="checkbox"/>	<input checked="" type="checkbox"/>																			
stoßfest	<input type="checkbox"/>	<input checked="" type="checkbox"/>	<input checked="" type="checkbox"/>																			
bodenschonend	<input type="checkbox"/>	<input checked="" type="checkbox"/>	<input checked="" type="checkbox"/>																			
witterungsbeständig	<input type="checkbox"/>	<input checked="" type="checkbox"/>	<input checked="" type="checkbox"/>																			

Technische Details

ORDERNO (Artikel-nummer)	CRT 175 TLK
WDAB (Rad-Ø A x Breite B / mm)	175x40
LC (Tragkraft / kg)	300
H (Bauhöhe H / mm)	216
HD (Loch-Ø / mm)	12.5
SR (Schwenkradius / mm)	168
WB (Radlager)	Kugellager