

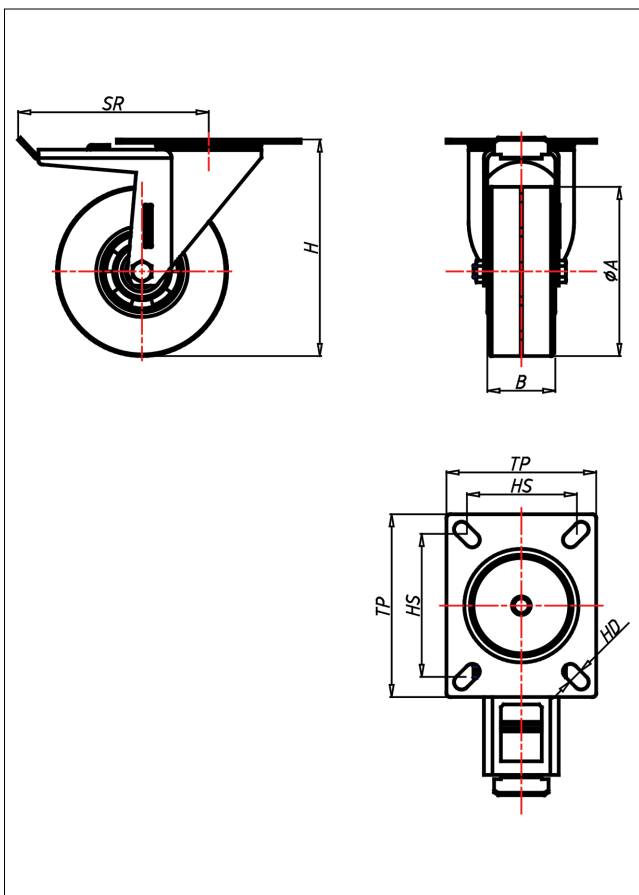

CDT/CST/CSST- EK/EB/LEK/LEB

Lenkrolle mit Totalfeststeller



CD-E



LENKROLLE	LENKROLLE MIT TOTALFESTSTELLER	BOCKROLLE																				
<ul style="list-style-type: none"> • hoher Fahrkomfort • sehr laufruhig • geringer Rollwiderstand • abriebfest • spurfrei in grau <p>ELASTIK-Vollgummi Felge Spritzguss- Aluminiumlegierung → Seite 259</p>	<p>zweifaches Kugellager - vernietet Stahlkugeln gehärtet, Dichtungsring, Radachse verschraubt, verzinkt- chrompassiviert</p> <p>→ Seite 62</p>	<p>AUSWAHLHILFE:</p> <table border="0"> <tr> <td>leicht lenkend</td> <td>+</td> <td>+</td> <td>+</td> </tr> <tr> <td>verschleißarm</td> <td>x</td> <td>x</td> <td>x</td> </tr> <tr> <td>stoßfest</td> <td>x</td> <td>x</td> <td>x</td> </tr> <tr> <td>bodenschonend</td> <td>+</td> <td>+</td> <td>+</td> </tr> <tr> <td>witterungsbeständig</td> <td>x</td> <td>x</td> <td>x</td> </tr> </table>	leicht lenkend	+	+	+	verschleißarm	x	x	x	stoßfest	x	x	x	bodenschonend	+	+	+	witterungsbeständig	x	x	x
leicht lenkend	+	+	+																			
verschleißarm	x	x	x																			
stoßfest	x	x	x																			
bodenschonend	+	+	+																			
witterungsbeständig	x	x	x																			

Technische Details

ORDERNO (Artikelnummer)	CST 160 EB
WDAB (Rad-Ø A x Breite B / mm)	160x50
LC (Tragkraft / kg)	300
H (Bauhöhe H / mm)	196
TP (Plattengröße / mm)	135x110
HS (Lochabstand / mm)	105x80
HD (Loch-Ø / mm)	11
SR (Schwenkradius / mm)	168
WB (Radlager)	Rollenlager