

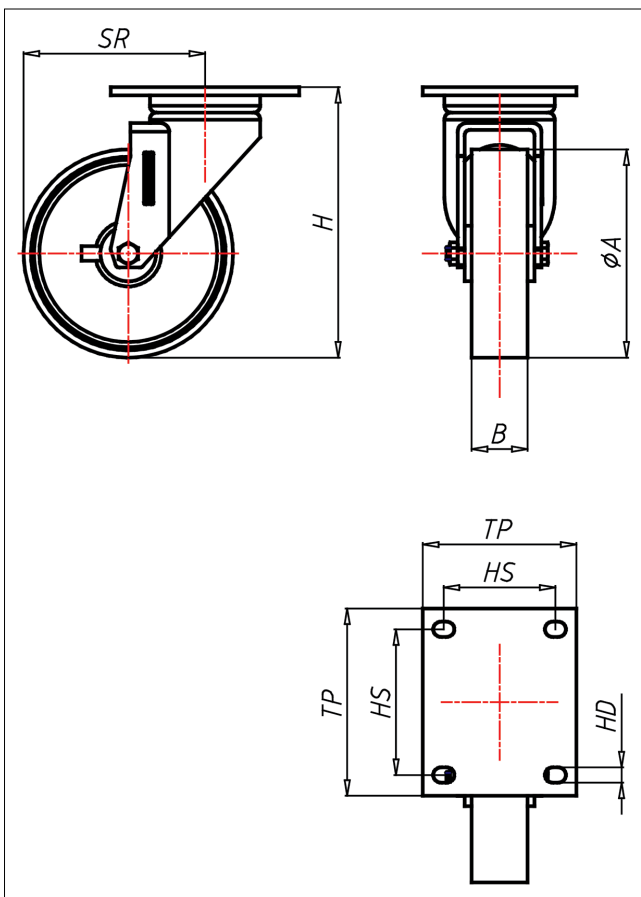

ED-PK/P/PB

Lenkrolle



ED-P



LENKROLLE	LENKROLLE MIT TOTALFESTSTELLER	BOCKROLLE																				
<ul style="list-style-type: none"> • leichter Lauf auf glatten Böden • stoß- und schlagfest • hohe Abriebfestigkeit • leicht zu reinigen • sehr beständig gegen viele aggressive Medien Polyamid 6 - 1. Wahl → Seite 272	<p>Schrägrollen- und Axialkugellager, staubgeschützt, sehr starker Zentralbolzen, Mutter gesichert, Schmiempel Ausführung – lackiert → Seite 26</p>	AUSWAHLHILFE: <table border="1"> <tr> <td>leicht lenkend</td> <td>+</td> <td>+</td> <td>+</td> </tr> <tr> <td>verschleißarm</td> <td>+</td> <td>+</td> <td>+</td> </tr> <tr> <td>stoßfest</td> <td>+</td> <td>+</td> <td>+</td> </tr> <tr> <td>bodenschonend</td> <td>+</td> <td>+</td> <td>+</td> </tr> <tr> <td>witterungsbeständig</td> <td>+</td> <td>+</td> <td>+</td> </tr> </table>	leicht lenkend	+	+	+	verschleißarm	+	+	+	stoßfest	+	+	+	bodenschonend	+	+	+	witterungsbeständig	+	+	+
leicht lenkend	+	+	+																			
verschleißarm	+	+	+																			
stoßfest	+	+	+																			
bodenschonend	+	+	+																			
witterungsbeständig	+	+	+																			

Technische Details

ORDERNO (Artikel-nummer)	ED 101 P
WDAB (Rad-Ø A x Breite B / mm)	100x37
LC (Tragkraft / kg)	250
H (Bauhöhe H / mm)	146
TP (Plattengröße / mm)	105x85
HS (Lochabstand / mm)	80x60
HD (Loch-Ø / mm)	9
SR (Schwenkradius / mm)	90
WB (Radlager)	Polyamid-Gleitlager