

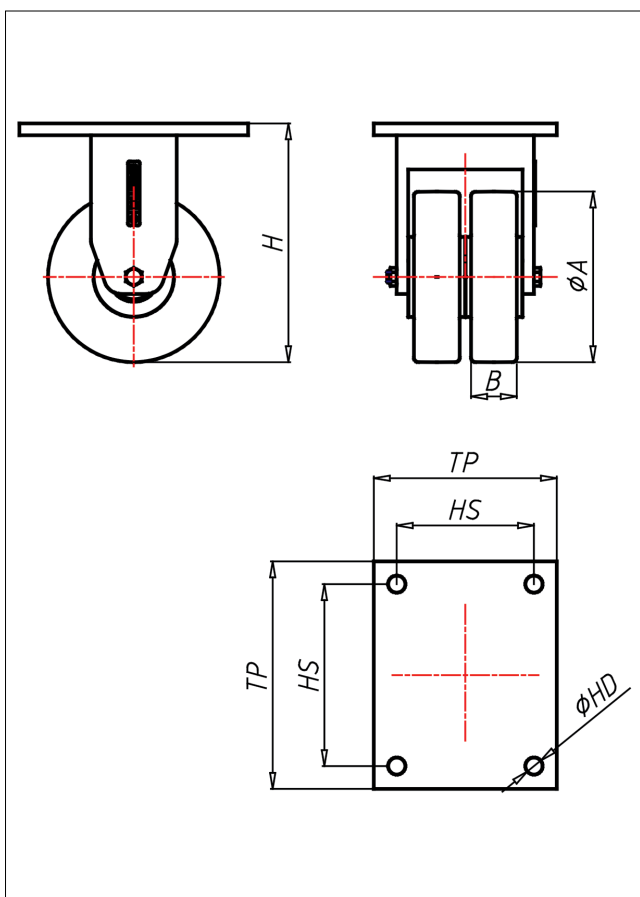

EDDF-PEK/PPEK

Bockrolle



EDD-PE



LENKROLLE	Feststeller TLCH Seite 42	BOCKROLLE																				
<ul style="list-style-type: none"> für extra schwere Lasten leichter Lauf auf glatten Böden stoß- und schlagfest hohe Abriebfestigkeit sehr beständig gegen viele aggressive Medien 	<p>Schrägrollen- und Axialkugellager, staubgeschützt, sehr starker Zentralbolzen, Mutter gesichert, Schmierlippe Ausführung – lackiert</p> <p>→ Seite 26</p>	<p>AUSWAHLHILFE:</p> <table border="0"> <tr> <td>leicht lenkend</td> <td>+</td> <td>+</td> <td>+</td> </tr> <tr> <td>verschleißarm</td> <td>+</td> <td>+</td> <td>+</td> </tr> <tr> <td>stoßfest</td> <td>+</td> <td>+</td> <td>+</td> </tr> <tr> <td>bodenschonend</td> <td>+</td> <td>+</td> <td>+</td> </tr> <tr> <td>witterungsbeständig</td> <td>+</td> <td>+</td> <td>+</td> </tr> </table>	leicht lenkend	+	+	+	verschleißarm	+	+	+	stoßfest	+	+	+	bodenschonend	+	+	+	witterungsbeständig	+	+	+
leicht lenkend	+	+	+																			
verschleißarm	+	+	+																			
stoßfest	+	+	+																			
bodenschonend	+	+	+																			
witterungsbeständig	+	+	+																			
Guss-Polyamid 6 - 1. Wahl → Seite 271																						

Technische Details

ORDERNO (Artikel-nummer)	EDDF 200 PPEK
WDAB (Rad-Ø A x Breite B / mm)	200x55+55
LC (Tragkraft / kg)	2000
H (Bauhöhe H / mm)	270
TP (Plattengröße / mm)	255x205
HS (Lochabstand / mm)	210x160
HD (Loch-Ø / mm)	15
WB (Radlager)	Kugellager