

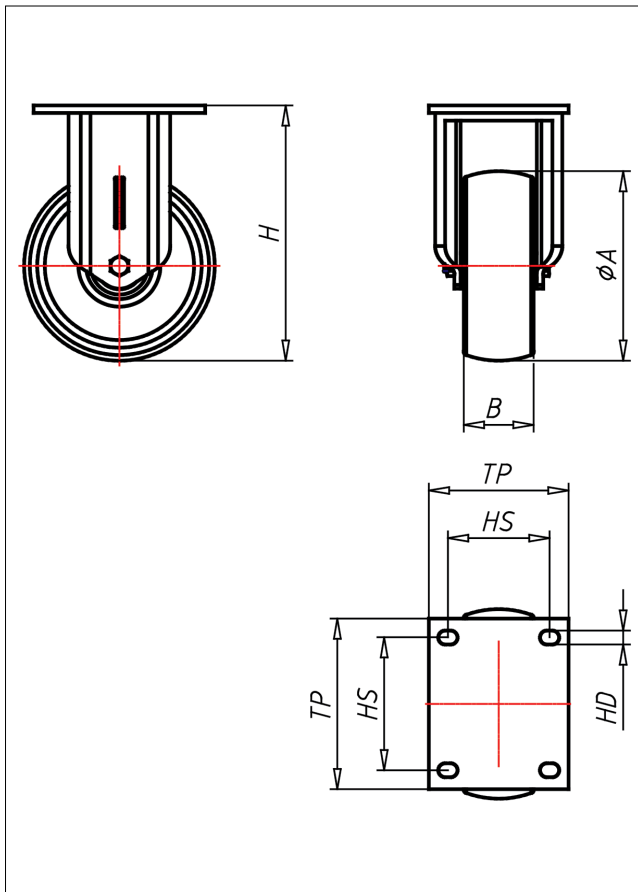

ED-QK/Q

Bockrolle



ED-Q



LENKROLLE	Feststeller TLCH Seite 42	BOCKROLLE																				
<ul style="list-style-type: none"> • leichter Lauf auf glatten Böden • sehr hohe Tragkraft • sehr abriebfest Gusseisen überdreht, lackiert → Seite 270	Schrägrollen- und Axialkugellager, staubgeschützt, sehr starker Zentralbolzen, Mütter gesichert, Schmiemoppel Ausführung – lackiert → Seite 26	AUSWAHLHILFE: <table border="0"> <tr> <td>leicht lenkend</td> <td>+</td> <td>+</td> <td>+</td> </tr> <tr> <td>verschleißarm</td> <td>+</td> <td>+</td> <td>+</td> </tr> <tr> <td>stoßfest</td> <td>+</td> <td>+</td> <td>+</td> </tr> <tr> <td>bodenschonend</td> <td>x</td> <td>+</td> <td>+</td> </tr> <tr> <td>witterungsbeständig</td> <td>+</td> <td>+</td> <td>x</td> </tr> </table>	leicht lenkend	+	+	+	verschleißarm	+	+	+	stoßfest	+	+	+	bodenschonend	x	+	+	witterungsbeständig	+	+	x
leicht lenkend	+	+	+																			
verschleißarm	+	+	+																			
stoßfest	+	+	+																			
bodenschonend	x	+	+																			
witterungsbeständig	+	+	x																			

Technische Details

ORDERNO (Artikel-nummer)	EDF 100 QK
WDAB (Rad-Ø A x Breite B / mm)	100x30
LC (Tragkraft / kg)	250
H (Bauhöhe H / mm)	145
TP (Plattengröße / mm)	105x85
HS (Lochabstand / mm)	80x60
HD (Loch-Ø / mm)	9
SR (Schwenkradius / mm)	90
WB (Radlager)	Kugellager