

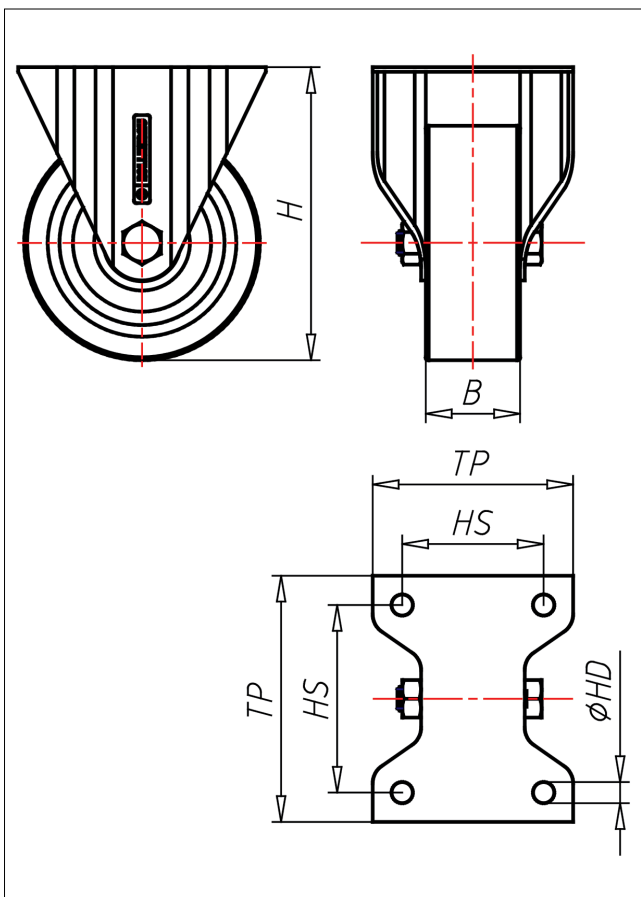

INVF/INF-PSBX

Bockrolle

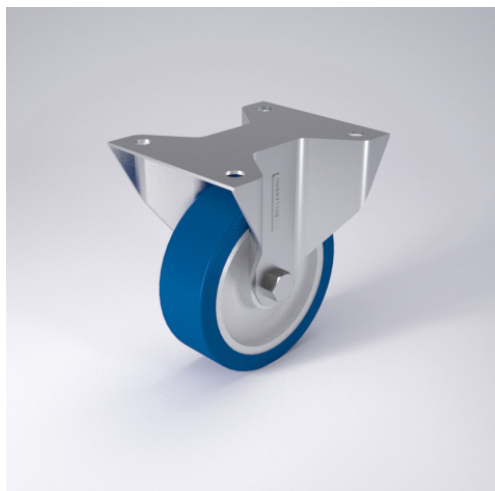

IN-PS



LENKROLLE	LENKROLLE MIT TOTALFESTSTELLER	BOCKROLLE																		
<ul style="list-style-type: none"> • sehr laufrichtig • geringer Rollwiderstand • abrieb- und reißfest • hohe Stoßfestigkeit • leichte Reinigung • sehr beständig gegen viele aggressive Medien <p>Polyurethan 87±3 Shore A weich Felge Polyamid 6 → Seite 254</p>	<p>zweifaches Kugellager - verschraubt, Staubschützing, Radachse verschraubt - gesichert, Edelstahl poliert</p> <p>→ Seite 110</p>	<p>AUSWAHLHILFE:</p> <table border="0"> <tr> <td>-</td> <td>+</td> <td>++</td> </tr> <tr> <td>leicht lenkend</td> <td>X</td> <td>X</td> </tr> <tr> <td>verschleißarm</td> <td>○</td> <td>X</td> </tr> <tr> <td>stoßfest</td> <td>X</td> <td>X</td> </tr> <tr> <td>bodenschonend</td> <td>○</td> <td>X</td> </tr> <tr> <td>witterungsbeständig</td> <td>○</td> <td>X</td> </tr> </table>	-	+	++	leicht lenkend	X	X	verschleißarm	○	X	stoßfest	X	X	bodenschonend	○	X	witterungsbeständig	○	X
-	+	++																		
leicht lenkend	X	X																		
verschleißarm	○	X																		
stoßfest	X	X																		
bodenschonend	○	X																		
witterungsbeständig	○	X																		

Technische Details

ORDERNO (Artikel-nummer)	INF 100 PSBX
WDAB (Rad-Ø A x Breite B / mm)	100x33
LC (Tragkraft / kg)	125
H (Bauhöhe H / mm)	125
TP (Plattengröße / mm)	105x85
HS (Lochabstand / mm)	80x60
HD (Loch-Ø / mm)	9
WB (Radlager)	Rollenlager