

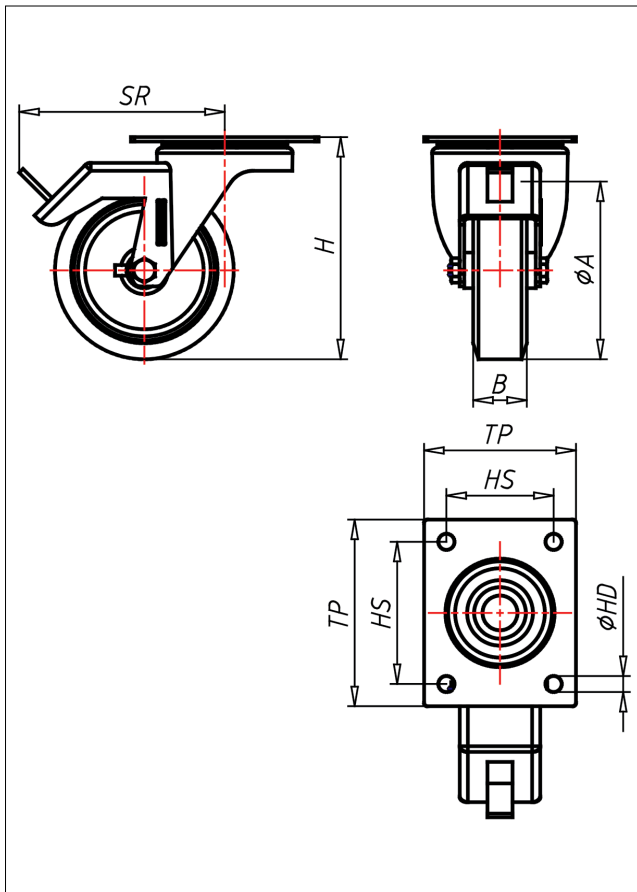

# INT/INVT-A/ABX

## Lenkrolle mit Totalfeststeller

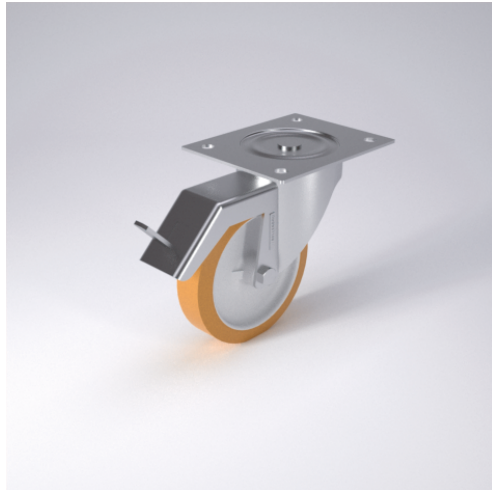

IN-A



LENKROLLE	LENKROLLE MIT TOTALFESTSTELLER	BOCKROLLE																		
 <ul style="list-style-type: none"> <li>• geräuscharmer Lauf</li> <li>• geringer Rollwiderstand</li> <li>• abrieb- und reißfest</li> <li>• hohe Stoßfestigkeit</li> <li>• leichte Reinigung</li> <li>• sehr beständig gegen viele aggressive Medien</li> </ul> <p>Guss-Polyurethan Felge Polyamid 6 → Seite 252</p> 	 <p>zweifaches Kugellager - verschraubt, Staubschützring, Radachse verschraubt - gesichert, Edelstahl poliert</p> <p>→ Seite 110</p>	 <p>AUSWAHLHILFE:</p> <table border="0"> <tr> <td>-</td> <td>+</td> <td>++</td> </tr> <tr> <td>leicht lenkend</td> <td>X</td> <td></td> </tr> <tr> <td>verschleißarm</td> <td></td> <td>X</td> </tr> <tr> <td>stoßfest</td> <td>X</td> <td></td> </tr> <tr> <td>bodenschonend</td> <td></td> <td>X</td> </tr> <tr> <td>witterungsbeständig</td> <td></td> <td>X</td> </tr> </table>	-	+	++	leicht lenkend	X		verschleißarm		X	stoßfest	X		bodenschonend		X	witterungsbeständig		X
-	+	++																		
leicht lenkend	X																			
verschleißarm		X																		
stoßfest	X																			
bodenschonend		X																		
witterungsbeständig		X																		

### Technische Details

<b>ORDERNO (Artikel-nummer)</b>	INT 100 ABX
<b>WDAB (Rad-Ø A x Breite B / mm)</b>	100x30
<b>LC (Tragkraft / kg)</b>	125
<b>H (Bauhöhe H / mm)</b>	125
<b>TP (Plattengröße / mm)</b>	105x85
<b>HS (Lochabstand / mm)</b>	80x60
<b>HD (Loch-Ø / mm)</b>	9
<b>SR (Schwenkradius / mm)</b>	120
<b>WB (Radlager)</b>	Rollenlager