

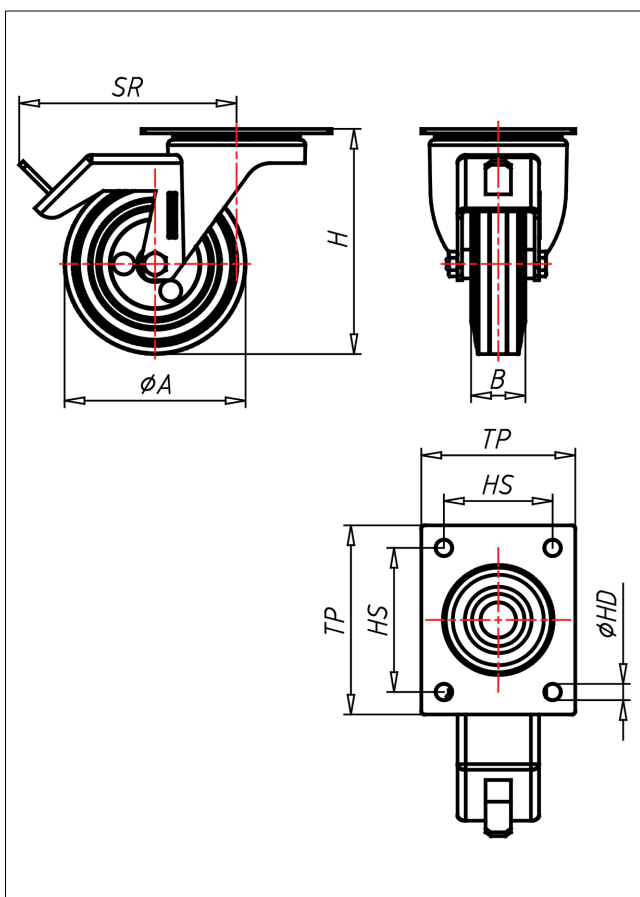

INT/INVT-ELBX

Lenkrolle mit Totalfeststeller



IN-EL



LENKROLLE	LENKROLLE MIT TOTALFESTSTELLER	BOCKROLLE																		
 <ul style="list-style-type: none"> • elektrisch leitfähig • Widerstand <math><10^{\circ}\Omega</math> • geräuscharmer Lauf • großer Fahrkomfort • beständig gegen verdünnte Säuren <p>Vollgummi schwarz Felge aus Edelstahl → Seite 267</p> 	 <p>zweifaches Kugellager - verschraubt, Staubschützring, Radachse verschraubt - gesichert, Edelstahl poliert</p> <p>→ Seite 110</p>	 <p>AUSWAHLHILFE:</p> <table border="0"> <tr> <td>-</td> <td>+</td> <td>++</td> </tr> <tr> <td>leicht lenkend</td> <td>X</td> <td>X</td> </tr> <tr> <td>verschleißarm</td> <td>X</td> <td>X</td> </tr> <tr> <td>stoßfest</td> <td>X</td> <td>X</td> </tr> <tr> <td>bodenschonend</td> <td>X</td> <td>X</td> </tr> <tr> <td>witterungsbeständig</td> <td>X</td> <td>X</td> </tr> </table>	-	+	++	leicht lenkend	X	X	verschleißarm	X	X	stoßfest	X	X	bodenschonend	X	X	witterungsbeständig	X	X
-	+	++																		
leicht lenkend	X	X																		
verschleißarm	X	X																		
stoßfest	X	X																		
bodenschonend	X	X																		
witterungsbeständig	X	X																		

Technische Details

ORDERNO (Artikel-nummer)	INT 100 ELBX
WDAB (Rad-Ø A x Breite B / mm)	100x30
LC (Tragkraft / kg)	100
H (Bauhöhe H / mm)	125
TP (Plattengröße / mm)	105x85
HS (Lochabstand / mm)	80x60
HD (Loch-Ø / mm)	9
SR (Schwenkradius / mm)	120
WB (Radlager)	Rollenlager