

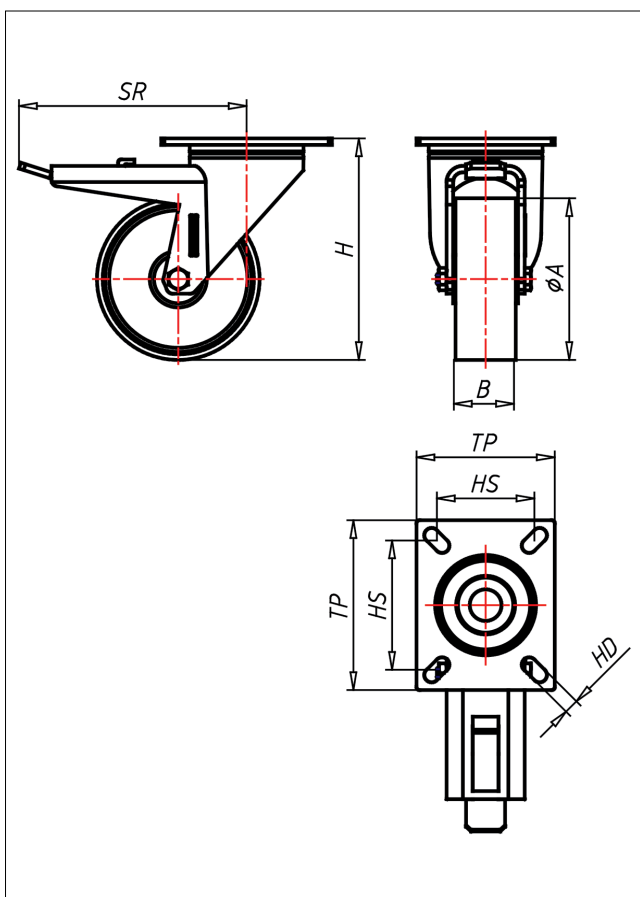

IPT/IPST/IPSST-P/PBX

Lenkrolle mit Totalfeststeller



IP-P



LENKROLLE	LENKROLLE MIT TOTALFESTSTELLER	BOCKROLLE																				
<ul style="list-style-type: none"> • leichter Lauf auf glatten Böden • stoß- und schlagfest • hohe Abriebfestigkeit • leicht zu reinigen • sehr beständig gegen viele aggressive Medien <p>Polyamid 6 - 1. Wahl → Seite 272</p>	<p>Gehäuse aus Edelstahl AISI 304, eingienieteter Zentralzapfen aus Edelstahl AISI 303, verschraubt, Wasser- und Staubabdichtungsring</p> <p>→ Seite 110</p>	<p>AUSWAHLHILFE:</p> <table border="0"> <tr> <td>leicht lenkend</td> <td>+</td> <td>+</td> <td>+</td> </tr> <tr> <td>verschleißarm</td> <td>+</td> <td>+</td> <td>+</td> </tr> <tr> <td>stoßfest</td> <td>+</td> <td>+</td> <td>+</td> </tr> <tr> <td>bodenschonend</td> <td>+</td> <td>+</td> <td>+</td> </tr> <tr> <td>witterungsbeständig</td> <td>+</td> <td>+</td> <td>+</td> </tr> </table>	leicht lenkend	+	+	+	verschleißarm	+	+	+	stoßfest	+	+	+	bodenschonend	+	+	+	witterungsbeständig	+	+	+
leicht lenkend	+	+	+																			
verschleißarm	+	+	+																			
stoßfest	+	+	+																			
bodenschonend	+	+	+																			
witterungsbeständig	+	+	+																			

Technische Details

ORDERNO (Artikelnummer)	IPT 150 P
WDAB (Rad-Ø A x Breite B / mm)	150x45
LC (Tragkraft / kg)	350
H (Bauhöhe H / mm)	192
TP (Plattengröße / mm)	135x110
HS (Lochabstand / mm)	105x80
HD (Loch-Ø / mm)	11
SR (Schwenkradius / mm)	170
WB (Radlager)	Polyamid-Gleitlager