

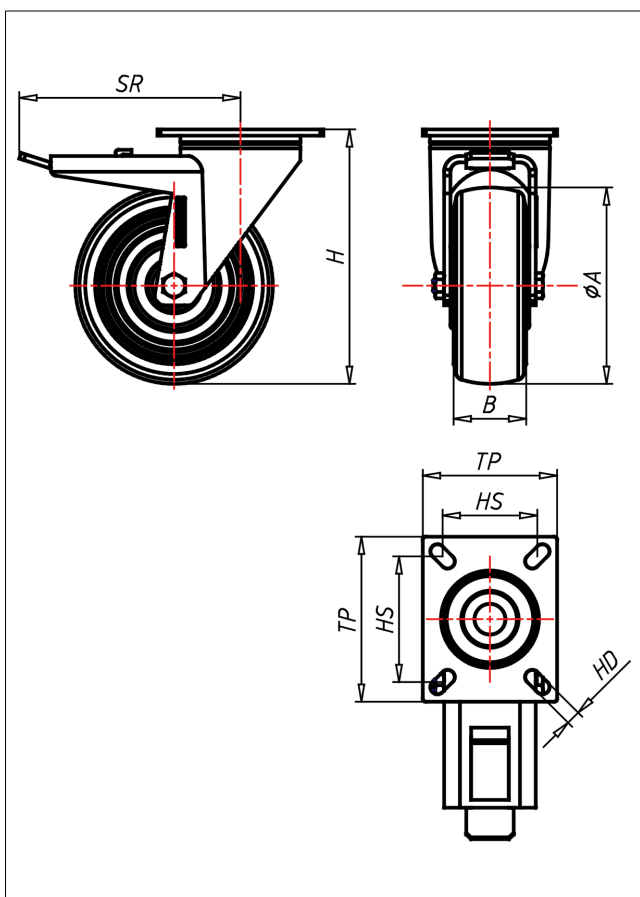

IPT/IPST-AELK

Lenkrolle mit Totalfeststeller



IP-AEL



LENKROLLE	LENKROLLE MIT TOTALFESTSTELLER	BOCKROLLE															
 <ul style="list-style-type: none"> • elektrisch leitfähig • geräuscharmer Lauf • geringer Rollwiderstand • spurfrei • hohe Stoßfestigkeit • sehr beständig gegen viele aggressive Medien <p>Polyurethan Felge Polyamid 6 → Seite 255</p> 	 <p>Gehäuse aus Edelstahl AISI 304, eingewiteter Zentralzapfen aus Edelstahl AISI 303, verschraubt, Wasser- und Staubabdichtungsring</p> <p>→ Seite 110</p>	 <p>AUSWAHLHILFE:</p> <table border="0"> <tr> <td>leicht lenkend</td> <td>+</td> <td>+</td> </tr> <tr> <td>verschleißarm</td> <td>+</td> <td>+</td> </tr> <tr> <td>stoßfest</td> <td>+</td> <td>+</td> </tr> <tr> <td>bodenschonend</td> <td>+</td> <td>+</td> </tr> <tr> <td>witterungsbeständig</td> <td>+</td> <td>+</td> </tr> </table>	leicht lenkend	+	+	verschleißarm	+	+	stoßfest	+	+	bodenschonend	+	+	witterungsbeständig	+	+
leicht lenkend	+	+															
verschleißarm	+	+															
stoßfest	+	+															
bodenschonend	+	+															
witterungsbeständig	+	+															

Technische Details

ORDERNO (Artikel-nummer)	IPT 160 AELK
WDAB (Rad-Ø A x Breite B / mm)	160x46
LC (Tragkraft / kg)	400
H (Bauhöhe H / mm)	192
TP (Plattengröße / mm)	135x110
HS (Lochabstand / mm)	105x80
HD (Loch-Ø / mm)	11
SR (Schwenkradius / mm)	170
WB (Radlager)	Kugellager