

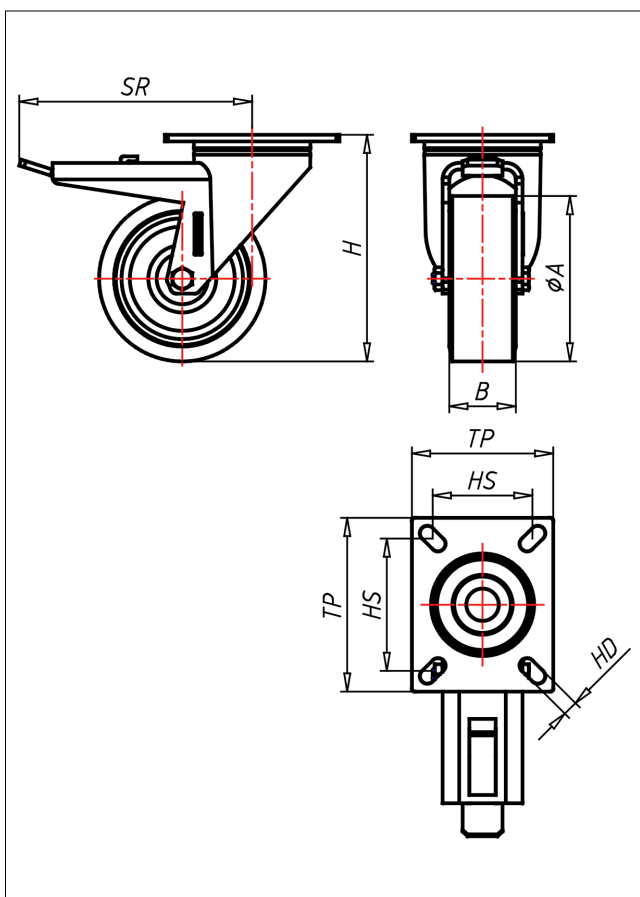

IPT/IPST-RNBX/RN

Lenkrolle mit Totalfeststeller

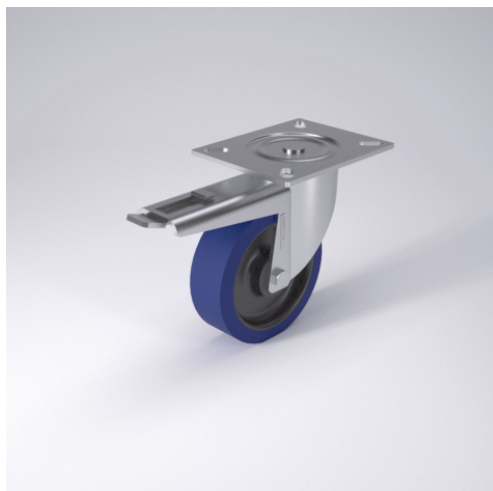

IP-RN



LENKROLLE	LENKROLLE MIT TOTALFESTSTELLER	BOCKROLLE																									
 <ul style="list-style-type: none"> • hoher Fahrkomfort • sehr laufruhig • geringer Rollwiderstand • abriebfest • korrosionsbeständig • spurfrei <p>ELASTIK-Vollgummi Felge Polyamid 6 → Seite 200</p> 	 <p>Gehäuse aus Edelstahl AISI 304, eingetiefeter Zentrazapfen aus Edelstahl AISI 303, verschraubt, Wasser- und Staubabdichtungsring → Seite 110</p>	 <p>AUSWAHLHILFE:</p> <table border="0"> <tr> <td>leicht lenkend</td> <td><input checked="" type="checkbox"/></td> <td><input type="checkbox"/></td> <td><input type="checkbox"/></td> <td><input type="checkbox"/></td> </tr> <tr> <td>verschleißarm</td> <td><input type="checkbox"/></td> <td><input type="checkbox"/></td> <td><input type="checkbox"/></td> <td><input type="checkbox"/></td> </tr> <tr> <td>stoßfest</td> <td><input type="checkbox"/></td> <td><input type="checkbox"/></td> <td><input type="checkbox"/></td> <td><input type="checkbox"/></td> </tr> <tr> <td>bodenschonend</td> <td><input type="checkbox"/></td> <td><input type="checkbox"/></td> <td><input type="checkbox"/></td> <td><input type="checkbox"/></td> </tr> <tr> <td>witterungsbeständig</td> <td><input type="checkbox"/></td> <td><input type="checkbox"/></td> <td><input type="checkbox"/></td> <td><input type="checkbox"/></td> </tr> </table>	leicht lenkend	<input checked="" type="checkbox"/>	<input type="checkbox"/>	<input type="checkbox"/>	<input type="checkbox"/>	verschleißarm	<input type="checkbox"/>	<input type="checkbox"/>	<input type="checkbox"/>	<input type="checkbox"/>	stoßfest	<input type="checkbox"/>	<input type="checkbox"/>	<input type="checkbox"/>	<input type="checkbox"/>	bodenschonend	<input type="checkbox"/>	<input type="checkbox"/>	<input type="checkbox"/>	<input type="checkbox"/>	witterungsbeständig	<input type="checkbox"/>	<input type="checkbox"/>	<input type="checkbox"/>	<input type="checkbox"/>
leicht lenkend	<input checked="" type="checkbox"/>	<input type="checkbox"/>	<input type="checkbox"/>	<input type="checkbox"/>																							
verschleißarm	<input type="checkbox"/>	<input type="checkbox"/>	<input type="checkbox"/>	<input type="checkbox"/>																							
stoßfest	<input type="checkbox"/>	<input type="checkbox"/>	<input type="checkbox"/>	<input type="checkbox"/>																							
bodenschonend	<input type="checkbox"/>	<input type="checkbox"/>	<input type="checkbox"/>	<input type="checkbox"/>																							
witterungsbeständig	<input type="checkbox"/>	<input type="checkbox"/>	<input type="checkbox"/>	<input type="checkbox"/>																							

Technische Details

ORDERNO (Artikel-nummer)	IPT 180 RNBX
WDAB (Rad-Ø A x Breite B / mm)	180x50
LC (Tragkraft / kg)	350
H (Bauhöhe H / mm)	238
TP (Plattengröße / mm)	135x110
HS (Lochabstand / mm)	105x80
HD (Loch-Ø / mm)	13
SR (Schwenkradius / mm)	170
WB (Radlager)	Rollenlager