

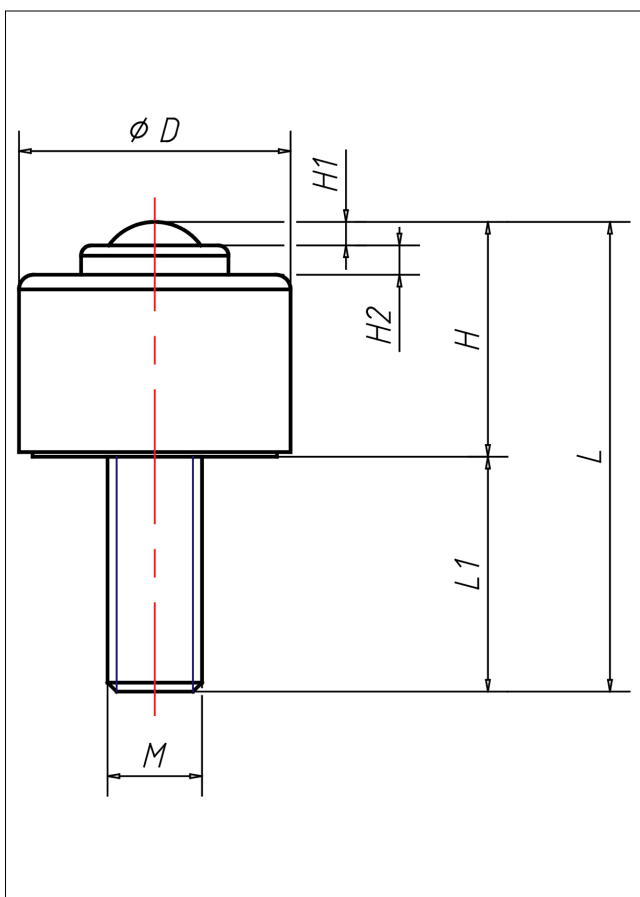

IS Minikugelrollen



IS Minikugelrollen

+70 °C
-30 °C max. 72 kg

N SN	SNM	
		Serie N: Gehäuse und Kugeln aus Carbonstahl
		Serie SN: Gehäuse und Kugeln aus Edelstahl
		Serie SNM: Gehäuse aus Aluminium, Kugeln aus Edelstahl, konische Ausführung

Technische Details

ORDERNO (Artikel-nummer)	IS-08N
BALL (Kugel-Ø / mm)	7.9
LC (Tragkraft / kg)	30
H2 (/ mm)	-
H1 (/ mm)	2
D1 (/ mm)	18
L1 (/ mm)	18
L (/ mm)	32
H (/ mm)	14
M ()	M8
WE (Gewicht / kg)	0.03