

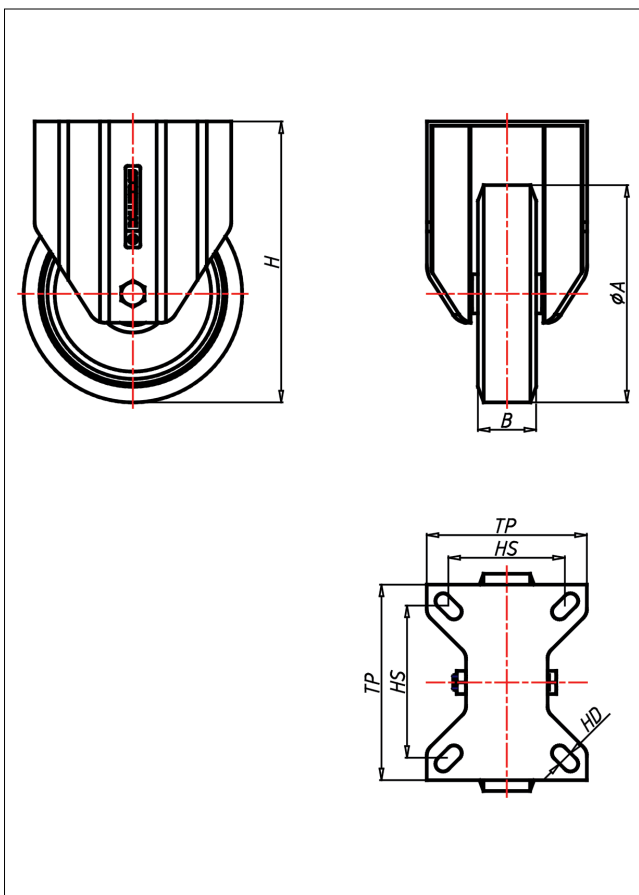

KDF-AK/AB/A

Bockrolle

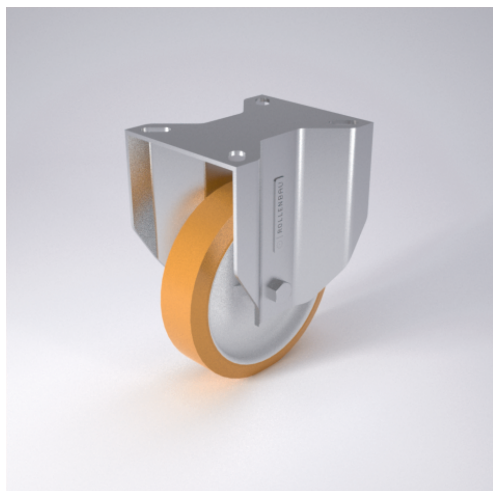

KD-A



LENKROLLE	LENKROLLE MIT TOTALFESTSTELLER	BOCKROLLE															
<ul style="list-style-type: none"> geräuscharmer Lauf geringer Rollwiderstand abrieb- und reißfest hohe Stoßfestigkeit leichte Reinigung sehr beständig gegen viele aggressive Medien 	<p>Laufkugeln gehärtet, Kugelbahnen gepresst, starker Zentralzapfen verschraubt - gedichtet - gesichert Staubschutzring, verzinkt</p> <p>→ Seite 62</p>	<p>AUSWAHLHILFE:</p> <table border="0"> <tr> <td>leicht lenkend</td> <td><input checked="" type="checkbox"/></td> <td><input checked="" type="checkbox"/></td> </tr> <tr> <td>verschleißarm</td> <td><input checked="" type="checkbox"/></td> <td><input checked="" type="checkbox"/></td> </tr> <tr> <td>stoßfest</td> <td><input checked="" type="checkbox"/></td> <td><input checked="" type="checkbox"/></td> </tr> <tr> <td>bodenschonend</td> <td><input checked="" type="checkbox"/></td> <td><input checked="" type="checkbox"/></td> </tr> <tr> <td>witterungsbeständig</td> <td><input checked="" type="checkbox"/></td> <td><input checked="" type="checkbox"/></td> </tr> </table>	leicht lenkend	<input checked="" type="checkbox"/>	<input checked="" type="checkbox"/>	verschleißarm	<input checked="" type="checkbox"/>	<input checked="" type="checkbox"/>	stoßfest	<input checked="" type="checkbox"/>	<input checked="" type="checkbox"/>	bodenschonend	<input checked="" type="checkbox"/>	<input checked="" type="checkbox"/>	witterungsbeständig	<input checked="" type="checkbox"/>	<input checked="" type="checkbox"/>
leicht lenkend	<input checked="" type="checkbox"/>	<input checked="" type="checkbox"/>															
verschleißarm	<input checked="" type="checkbox"/>	<input checked="" type="checkbox"/>															
stoßfest	<input checked="" type="checkbox"/>	<input checked="" type="checkbox"/>															
bodenschonend	<input checked="" type="checkbox"/>	<input checked="" type="checkbox"/>															
witterungsbeständig	<input checked="" type="checkbox"/>	<input checked="" type="checkbox"/>															
<p>Guss-Polyurethan Felge Polyamid 6 → Seite 252</p>																	

Technische Details

ORDERNO (Artikel-nummer)	KDF 175 AK
WDAB (Rad-Ø A x Breite B / mm)	175x40
LC (Tragkraft / kg)	450
H (Bauhöhe H / mm)	237
TP (Plattengröße / mm)	135x110
HS (Lochabstand / mm)	105x80
HD (Loch-Ø / mm)	12.5
WB (Radlager)	Kugellager