

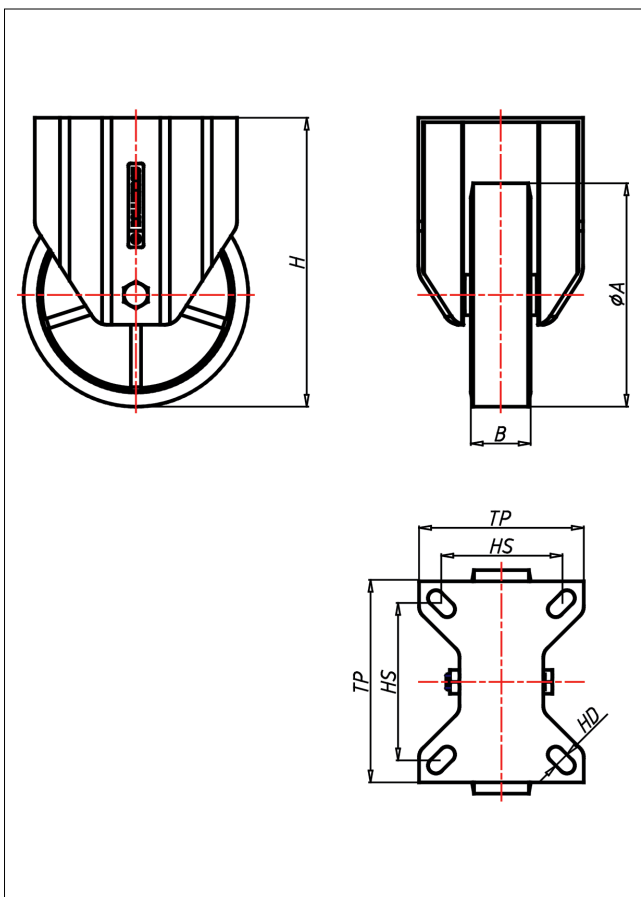

KDF-ZSK

Bockrolle

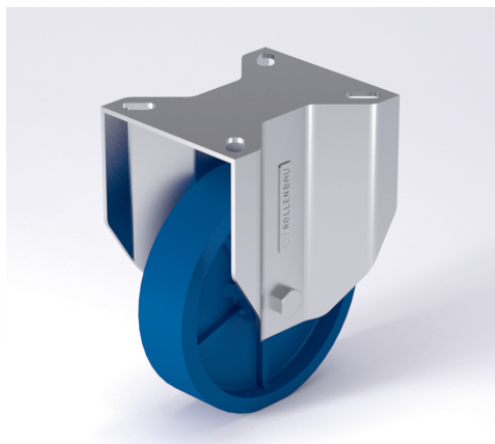

KD-ZS



NEU!

Lenkrolle Swivel Castor	Lenkrolle mit Totfallsteller Swivel Castor with total lock	Bockrolle Fixed Castor
<ul style="list-style-type: none"> sehr geräuscharmer Lauf geringer Rollwiderstand abrieb- und weildfest hohe Stoßfestigkeit sehr beständig gegen viele aggressive Medien 	<ul style="list-style-type: none"> Laufkugeln gehärtet, Kugelbahnen gepresst, starker Zentralzapfen verschraubt - gedichtet - gesichert Staubschuttring, verzinkt 	<ul style="list-style-type: none"> Auswahlhilfe Selection Criteria leicht lenkbar/swivels easily verschleißarm/wear resistant staubfest/dust proof bodenschonend/floor protective witterungsbeständig/weather proof
<ul style="list-style-type: none"> Guss-Polyurethane 85 + 3 shore A weich Felge Gussstahl lackiert → Seite/Page 325 	<ul style="list-style-type: none"> → Seite/Page 112 	

Technische Details

ORDERNO (Artikel-nummer)	KDF 200 ZSK
WDAB (Rad-Ø A x Breite B / mm)	200x50
LC (Tragkraft / kg)	450
H (Bauhöhe H / mm)	249
TP (Plattengröße / mm)	135x110
HS (Lochabstand / mm)	105x80
HD (Loch-Ø / mm)	12.5
SR (Schwenkradius / mm)	165
WB (Radlager)	Kugellager