

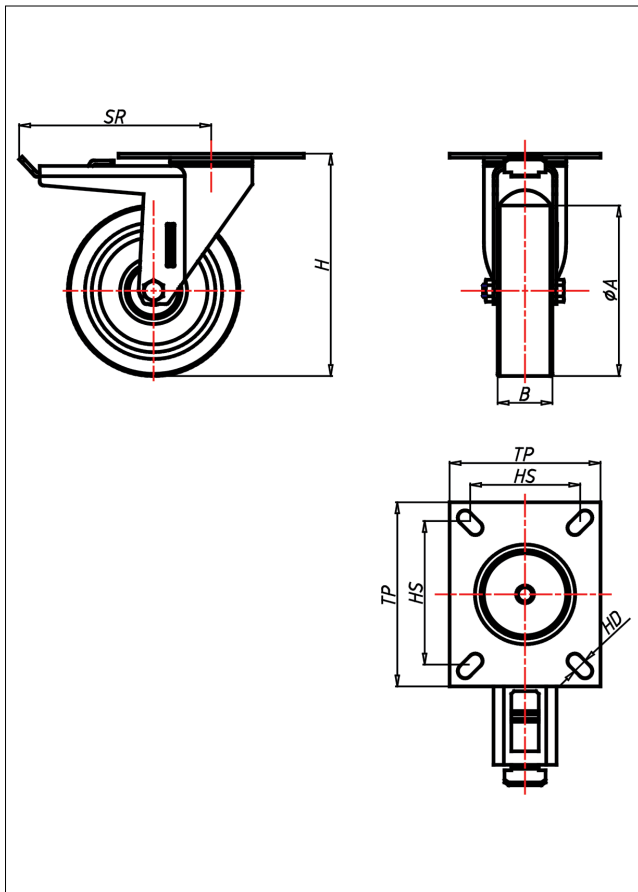

KDT-PSK/PSB

Lenkrolle mit Totalfeststeller



KD-PS



+80 °C
-30 °C max. 450 kg

LENKROLLE	LENKROLLE MIT TOTALFESTSTELLER	BOCKROLLE																									
<ul style="list-style-type: none"> • sehr laufruhig • geringer Rollwiderstand • abrieb- und reißfest • hohe Stoßfestigkeit • leichte Reinigung • sehr beständig gegen viele aggressive Medien <p>Polyurethan 87±3 Shore A weich Felge Polyamid 6 → Seite 254</p>	<p>Laufkugeln gehärtet, Kugelbahnen gepresst, starker Zentralzapfen verschraubt - gedichtet - gesichert Staubschutzring, verzinkt</p> <p>→ Seite 62</p>	<p>AUSWAHLHILFE:</p> <table border="0"> <tr> <td>leicht lenkend</td> <td>+</td> <td>+</td> <td>+</td> <td>+</td> </tr> <tr> <td>verschleißsarm</td> <td>x</td> <td>+</td> <td>+</td> <td>+</td> </tr> <tr> <td>stoßfest</td> <td>+</td> <td>+</td> <td>+</td> <td>+</td> </tr> <tr> <td>bodenschonend</td> <td>+</td> <td>+</td> <td>+</td> <td>+</td> </tr> <tr> <td>witterungsbeständig</td> <td>x</td> <td>+</td> <td>+</td> <td>+</td> </tr> </table>	leicht lenkend	+	+	+	+	verschleißsarm	x	+	+	+	stoßfest	+	+	+	+	bodenschonend	+	+	+	+	witterungsbeständig	x	+	+	+
leicht lenkend	+	+	+	+																							
verschleißsarm	x	+	+	+																							
stoßfest	+	+	+	+																							
bodenschonend	+	+	+	+																							
witterungsbeständig	x	+	+	+																							

Technische Details

ORDERNO (Artikel-nummer)	KDT 125 PSB
WDAB (Rad-Ø A x Breite B / mm)	125x40
LC (Tragkraft / kg)	300
H (Bauhöhe H / mm)	163
TP (Plattengröße / mm)	135x110
HS (Lochabstand / mm)	105x80
HD (Loch-Ø / mm)	10.5
SR (Schwenkradius / mm)	140
WB (Radlager)	Rollenlager