

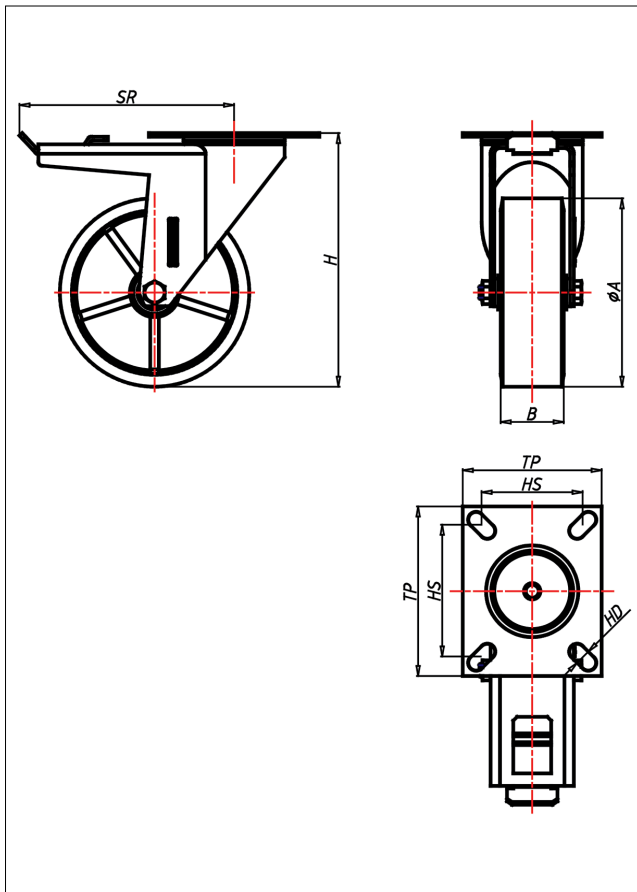

KDT-ZSK

Lenkrolle mit Totalfeststeller

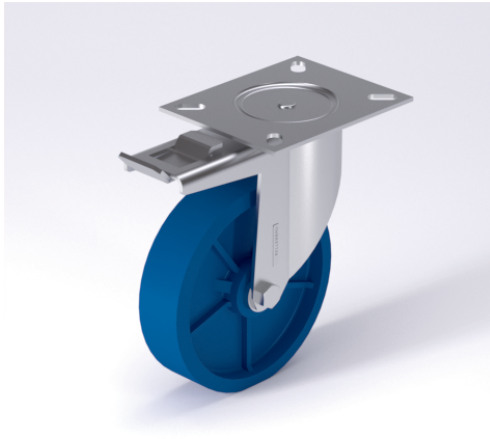

KD-ZS



NEU!

Lenkrolle Swivel Castor	Lenkrolle mit Totalfeststeller Swivel Castor with total lock	Bockrolle Fixed Castor
<ul style="list-style-type: none"> sehr geräuscharmer Lauf geringer Rollwiderstand stöße- und weildfest hohe Stoßfestigkeit sehr beständig gegen viele aggressive Medien 	<ul style="list-style-type: none"> Laufkugeln gehärtet, Kugelbahnen gepresst, starker Zentralzapfen verschraubt - gedichtet - gesichert Staubschutzing, verzinkt 	<ul style="list-style-type: none"> Auswahlhilfe Selection Criteria leicht lenkend/swivels easily verschleißarm/wear resistant stoßfest/impact proof bodenschonend/floor protective witterungsbeständig/weather proof

Guss-Polyurethane 85 + 3 shore A weich
 Folge Gussseisen lackiert
 → Seite/Page 325

→ Seite/Page 112

Technische Details

ORDERNO (Artikel-nummer)	KDT 250 ZSK
WDAB (Rad-Ø A x Breite B / mm)	250x50
LC (Tragkraft / kg)	450
H (Bauhöhe H / mm)	304
TP (Plattengröße / mm)	135x110
HS (Lochabstand / mm)	105x80
HD (Loch-Ø / mm)	12.5
SR (Schwenkradius / mm)	196
WB (Radlager)	Kugellager