

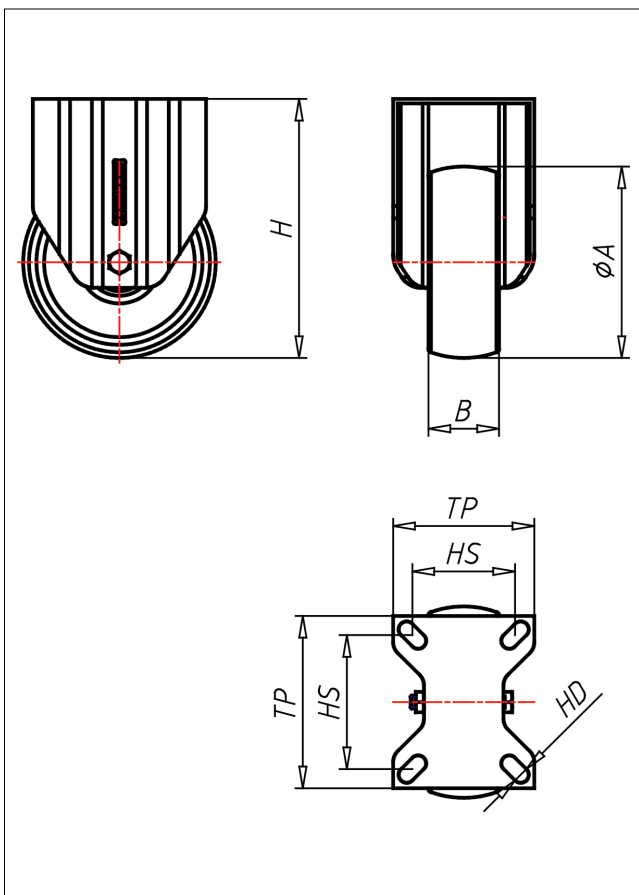

PDF/PSF-Q/QK

Bockrolle

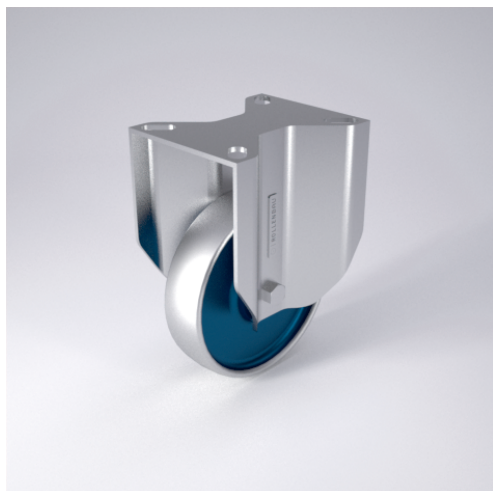

PD-Q



LENKROLLE	LENKROLLE MIT TOTALFESTSTELLER	BOCKROLLE															
<ul style="list-style-type: none"> • leichter Lauf auf glatten Böden • sehr hohe Tragkraft • sehr abriebfest <p>Gusseisen überdreht, lackiert</p> <p>→ Seite 270</p>	<p>gehärtete Stahlkugeln, zweifache Kugelbahnen aus gehärtetem Stahlblech, mit starkem Zentralzapfen verschraubt und gesichert - nachstellbar</p> <p>→ Seite 42</p>	<p>AUSWAHLHILFE:</p> <table border="1"> <tr> <td>leicht lenkend</td> <td><input checked="" type="checkbox"/></td> <td><input checked="" type="checkbox"/></td> </tr> <tr> <td>verschleißarm</td> <td><input checked="" type="checkbox"/></td> <td><input checked="" type="checkbox"/></td> </tr> <tr> <td>stoßfest</td> <td><input checked="" type="checkbox"/></td> <td><input checked="" type="checkbox"/></td> </tr> <tr> <td>bodenschonend</td> <td><input checked="" type="checkbox"/></td> <td><input checked="" type="checkbox"/></td> </tr> <tr> <td>witterungsbeständig</td> <td><input checked="" type="checkbox"/></td> <td><input checked="" type="checkbox"/></td> </tr> </table>	leicht lenkend	<input checked="" type="checkbox"/>	<input checked="" type="checkbox"/>	verschleißarm	<input checked="" type="checkbox"/>	<input checked="" type="checkbox"/>	stoßfest	<input checked="" type="checkbox"/>	<input checked="" type="checkbox"/>	bodenschonend	<input checked="" type="checkbox"/>	<input checked="" type="checkbox"/>	witterungsbeständig	<input checked="" type="checkbox"/>	<input checked="" type="checkbox"/>
leicht lenkend	<input checked="" type="checkbox"/>	<input checked="" type="checkbox"/>															
verschleißarm	<input checked="" type="checkbox"/>	<input checked="" type="checkbox"/>															
stoßfest	<input checked="" type="checkbox"/>	<input checked="" type="checkbox"/>															
bodenschonend	<input checked="" type="checkbox"/>	<input checked="" type="checkbox"/>															
witterungsbeständig	<input checked="" type="checkbox"/>	<input checked="" type="checkbox"/>															

Technische Details

ORDERNO (Artikel-nummer)	PDF 130 Q
WDAB (Rad-Ø A x Breite B / mm)	130x40
LC (Tragkraft / kg)	450
H (Bauhöhe H / mm)	166
TP (Plattengröße / mm)	135x110
HS (Lochabstand / mm)	105x80
HD (Loch-Ø / mm)	10.5
WB (Radlager)	Gleitlager