

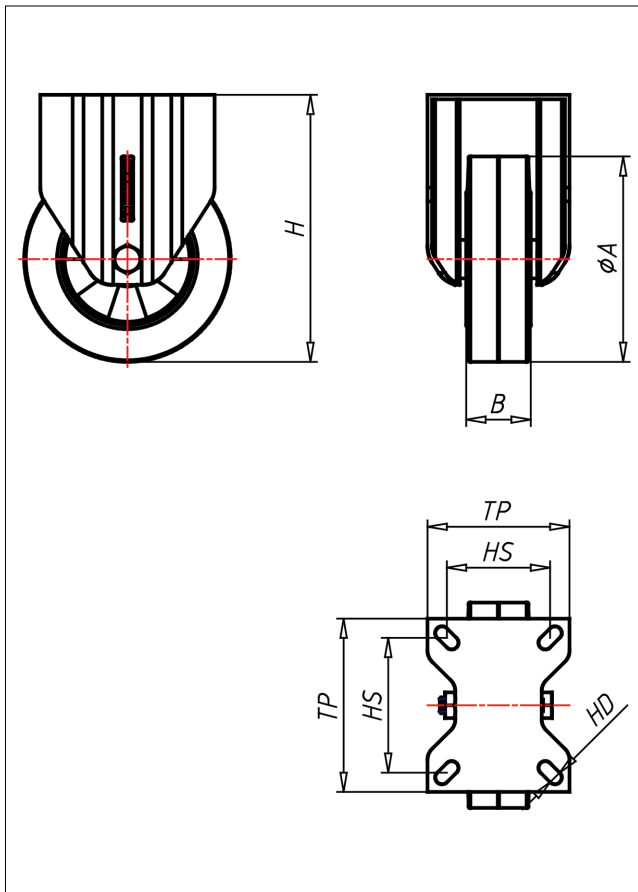

PDF/PSF- EK/EB/LEK/LEB Bockrolle

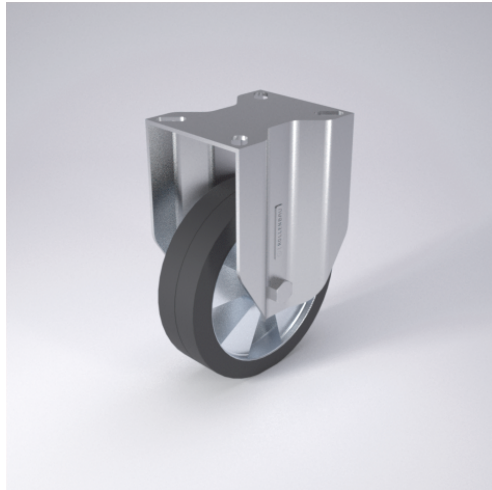

PD-E



LENKROLLE	LENKROLLE MIT TOTALFESTSTELLER	BOCKROLLE															
<ul style="list-style-type: none"> • hoher Fahrkomfort • sehr laufruhig • geringer Rollwiderstand • abriebfest • spurfrei in grau <p>ELASTIK-Vollgummi Felge Spritzguss-Aluminiumgehäuse → Seite 259</p>	<p>gehärtete Stahlkugeln, zweifache Kugelbahnen aus gehärtetem Stahlblech, mit starkem Zentralzapfen verschraubt und gesichert - nachstellbar</p> <p>→ Seite 42</p>	<p>AUSWAHLHILFE:</p> <table border="1"> <tr> <td>leicht lenkend</td> <td>X</td> <td>X</td> </tr> <tr> <td>verschleißarm</td> <td>X</td> <td>X</td> </tr> <tr> <td>stoßfest</td> <td>X</td> <td>X</td> </tr> <tr> <td>bodenschonend</td> <td>X</td> <td>X</td> </tr> <tr> <td>witterungsbeständig</td> <td>X</td> <td>X</td> </tr> </table>	leicht lenkend	X	X	verschleißarm	X	X	stoßfest	X	X	bodenschonend	X	X	witterungsbeständig	X	X
leicht lenkend	X	X															
verschleißarm	X	X															
stoßfest	X	X															
bodenschonend	X	X															
witterungsbeständig	X	X															

Technische Details

ORDERNO (Artikel-nummer)	PDF 200 EK
WDAB (Rad-Ø A x Breite B / mm)	200x50
LC (Tragkraft / kg)	450
H (Bauhöhe H / mm)	250
TP (Plattengröße / mm)	135x110
HS (Lochabstand / mm)	105x80
HD (Loch-Ø / mm)	12.5
WB (Radlager)	Kugellager