

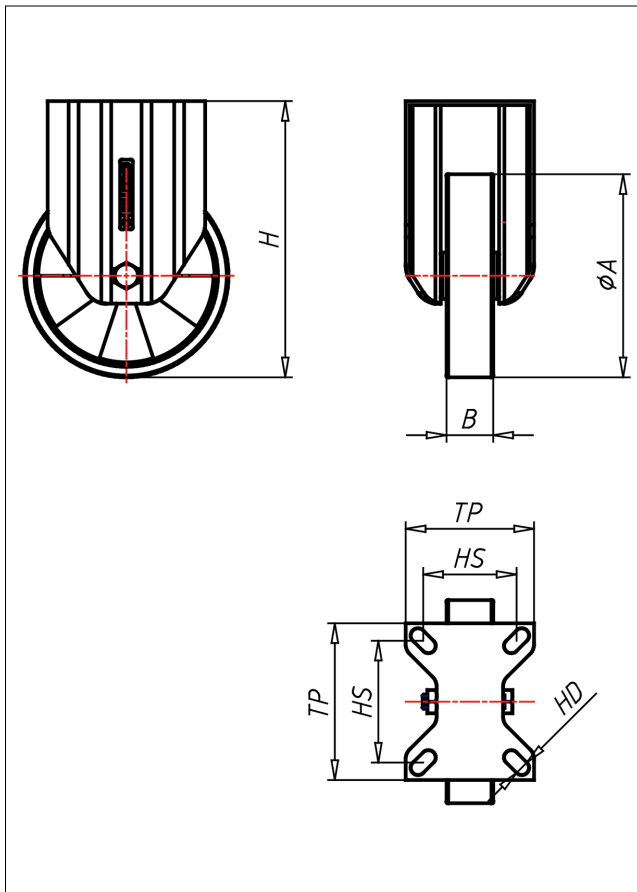

PDF/PSF-TLK/TLB

Bockrolle

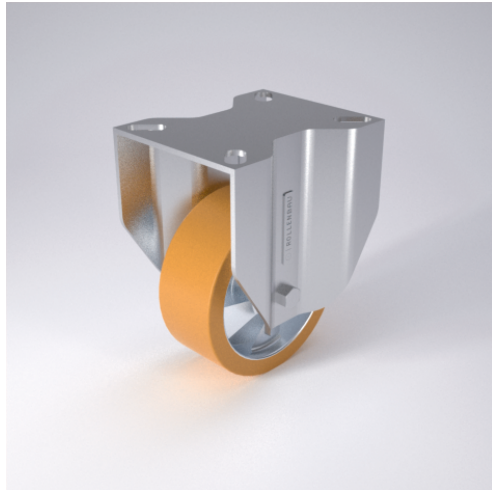

PD-TL



LENKROLLE	LENKROLLE MIT TOTALFESTSTELLER	BOCKROLLE															
<ul style="list-style-type: none"> geräuscharmer Lauf geringer Rollwiderstand abrieb- und reißfest hohe Stoßfestigkeit sehr beständig gegen viele aggressive Medien <p>Guss-Polyurethan Felge Spritzguss-Aluminium-Legierung → Seite 250</p>	<p>gehärtete Stahlkugeln, zweifache Kugelbahnen aus gehärtetem Stahlblech, mit starkem Zentralzapfen verschraubt und gesichert - nachstellbar → Seite 42</p>	<p>AUSWAHLHILFE:</p> <table border="0"> <tr> <td>leicht lenkend</td> <td>X</td> <td>X</td> </tr> <tr> <td>verschleißarm</td> <td>●</td> <td>X</td> </tr> <tr> <td>stoßfest</td> <td>●</td> <td>X</td> </tr> <tr> <td>bodenschonend</td> <td>●</td> <td>X</td> </tr> <tr> <td>witterungsbeständig</td> <td>X</td> <td>●</td> </tr> </table>	leicht lenkend	X	X	verschleißarm	●	X	stoßfest	●	X	bodenschonend	●	X	witterungsbeständig	X	●
leicht lenkend	X	X															
verschleißarm	●	X															
stoßfest	●	X															
bodenschonend	●	X															
witterungsbeständig	X	●															

Technische Details

ORDERNO (Artikel-nummer)	PDF 82 TLB
WDAB (Rad-Ø A x Breite B / mm)	80x40
LC (Tragkraft / kg)	250
H (Bauhöhe H / mm)	128
TP (Plattengröße / mm)	105x85
HS (Lochabstand / mm)	80x60
HD (Loch-Ø / mm)	8.5
WB (Radlager)	Rollenlager