

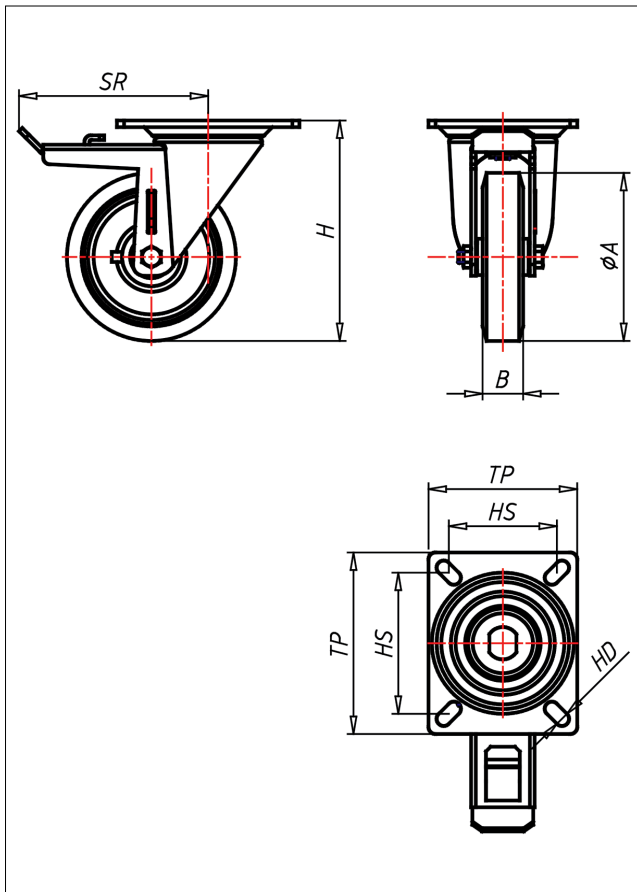

# PDT-AK/AB/A

## Lenkrolle mit Totalfeststeller



PD-A



LENKROLLE	LENKROLLE MIT TOTALFESTSTELLER	BOCKROLLE																		
 <ul style="list-style-type: none"> <li>• geräuscharmer Lauf</li> <li>• geringer Rollwiderstand</li> <li>• abrieb- und reißfest</li> <li>• hohe Stoßfestigkeit</li> <li>• leichte Reinigung</li> <li>• sehr beständig gegen viele aggressive Medien</li> </ul> <p>Guss-Polyurethan Felge Polyamid 6 → Seite 252</p> 	 <p>gehärtete Stahlkugeln, zweifache Kugelbahnen aus gehärtetem Stahlblech, mit starkem Zentralzapfen verschraubt und gesichert - nachstellbar</p> <p>→ Seite 42</p>	 <p>AUSWAHLHILFE:</p> <table border="0"> <tr> <td>-</td> <td>+</td> <td>++</td> </tr> <tr> <td>leicht lenkend</td> <td>X</td> <td>●</td> </tr> <tr> <td>verschleißarm</td> <td>●</td> <td>X</td> </tr> <tr> <td>stoßfest</td> <td>●</td> <td>X</td> </tr> <tr> <td>bodenschonend</td> <td>●</td> <td>X</td> </tr> <tr> <td>witterungsbeständig</td> <td>X</td> <td>●</td> </tr> </table>	-	+	++	leicht lenkend	X	●	verschleißarm	●	X	stoßfest	●	X	bodenschonend	●	X	witterungsbeständig	X	●
-	+	++																		
leicht lenkend	X	●																		
verschleißarm	●	X																		
stoßfest	●	X																		
bodenschonend	●	X																		
witterungsbeständig	X	●																		

### Technische Details

ORDERNO (Artikel-nummer)	PDT 125 AB
WDAB (Rad-Ø A x Breite B / mm)	125x30
LC (Tragkraft / kg)	250
H (Bauhöhe H / mm)	164
TP (Plattengröße / mm)	135x110
HS (Lochabstand / mm)	105x80
HD (Loch-Ø / mm)	10.5
SR (Schwenkradius / mm)	140
WB (Radlager)	Rollenlager