

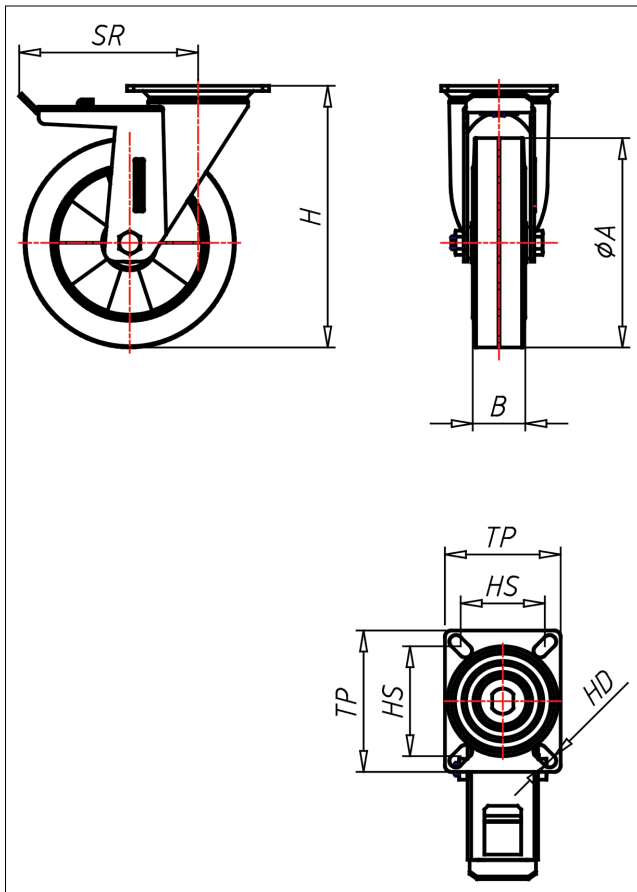

PDT/PST- EK/EB/LEK/LEB

Lenkrolle mit Totalfeststeller



PD-E



LENKROLLE	LENKROLLE MIT TOTALFESTSTELLER	BOCKROLLE
<ul style="list-style-type: none"> • hoher Fahrkomfort • sehr laufruhig • geringer Rollwiderstand • abriebfest • spurfrei in grau 	<ul style="list-style-type: none"> • gehärtete Stahlkugeln, zweifache Kugelbahnen aus gehärtetem Stahlblech, mit starkem Zentralzapfen verschraubt und gesichert - nachstellbar 	<p>AUSWAHLHILFE:</p> <ul style="list-style-type: none"> leicht lenkend <input checked="" type="checkbox"/> verschleißarm <input checked="" type="checkbox"/> stoßfest <input checked="" type="checkbox"/> bodenschonend <input checked="" type="checkbox"/> witterungsbeständig <input checked="" type="checkbox"/>
<p>ELASTIK-Vollgummi Felge Spritzguss-Aluminiumlagerung → Seite 259</p>	<p>→ Seite 42</p>	

Technische Details

ORDERNO (Artikel-nummer)	PDT 125 EB
WDAB (Rad-Ø A x Breite B / mm)	125x50
LC (Tragkraft / kg)	220
H (Bauhöhe H / mm)	164
TP (Plattengröße / mm)	135x110
HS (Lochabstand / mm)	105x80
HD (Loch-Ø / mm)	10.5
SR (Schwenkradius / mm)	140
WB (Radlager)	Rollenlager