

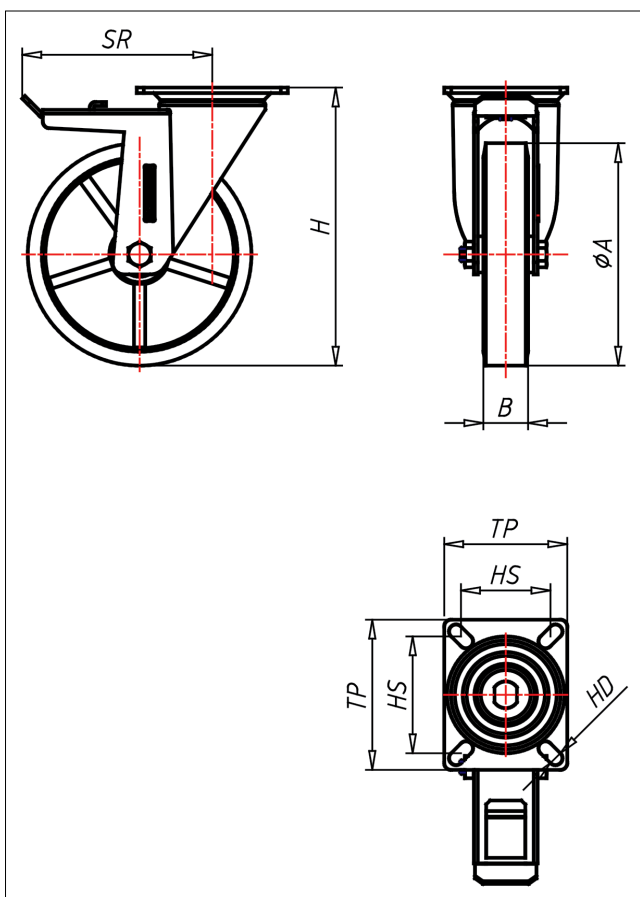

PDT/PST-ZK/LZK

Lenkrolle mit Totalfeststeller

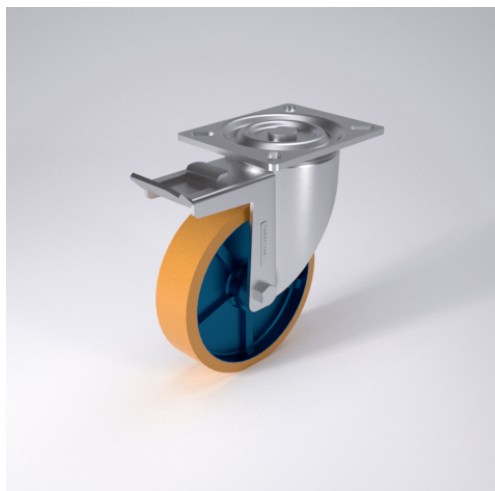

PD-Z



LENKROLLE	LENKROLLE MIT TOTALFESTSTELLER	BOCKROLLE																				
 <ul style="list-style-type: none"> geräuscharmer Lauf geringer Rollwiderstand abrieb- und reißfest hohe Stoßfestigkeit sehr beständig gegen viele aggressive Medien <p>Guss-Polyurethan Felge Gussisen lackiert → Seite 245</p> 	 <p>gehärtete Stahlkugeln, zweifache Kugelbahnen aus gehärtetem Stahlblech, mit starkem Zentralzapfen verschraubt und gesichert - nachstellbar</p> <p>→ Seite 42</p>	 <p>AUSWAHLHILFE:</p> <table border="1"> <tr> <td>leicht lenkend</td> <td>-</td> <td>+</td> <td>++</td> </tr> <tr> <td>verschleißarm</td> <td>x</td> <td></td> <td></td> </tr> <tr> <td>stoßfest</td> <td></td> <td>x</td> <td>x</td> </tr> <tr> <td>bodenschonend</td> <td></td> <td></td> <td>x</td> </tr> <tr> <td>witterungsbeständig</td> <td></td> <td>x</td> <td></td> </tr> </table>	leicht lenkend	-	+	++	verschleißarm	x			stoßfest		x	x	bodenschonend			x	witterungsbeständig		x	
leicht lenkend	-	+	++																			
verschleißarm	x																					
stoßfest		x	x																			
bodenschonend			x																			
witterungsbeständig		x																				

Technische Details

ORDERNO (Artikel-nummer)	PDT 127 ZK
WDAB (Rad-Ø A x Breite B / mm)	125x50
LC (Tragkraft / kg)	450
H (Bauhöhe H / mm)	164
TP (Plattengröße / mm)	135x110
HS (Lochabstand / mm)	105x80
HD (Loch-Ø / mm)	10.5
SR (Schwenkradius / mm)	140
WB (Radlager)	Kugellager