

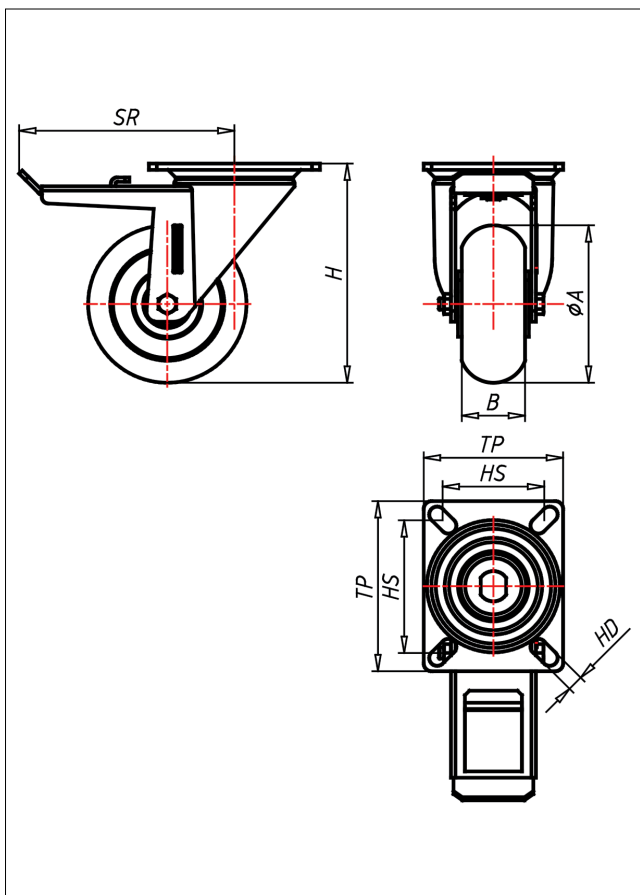

PST/PDT-TLSBAK

Lenkrolle mit Totalfeststeller

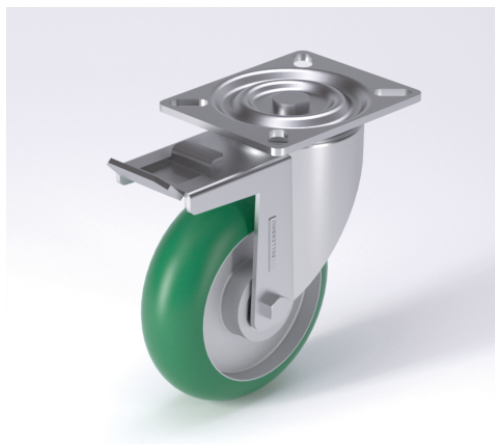

PD-TLSBA



NEU!

Lenkrolle Swivel Castor	Lenkrolle mit Totalfeststeller Swivel Castor with total lock	Bockrolle Fixed Castor																				
<ul style="list-style-type: none"> sehr geräuscharmer Lauf sehr geringer Rollwiderstand sehr drehfreudig abrieb- und reißfest sehr beständig gegen viele aggressive Medien <p>Guss-Polyurethan 85x2 Shore A weich ballig Folje Spritzguss-Aluminium-Legierung → Seite/Page 333</p>	<p>gehärtete Stahlkugeln, zweifache Kugelbahnen aus gehärtetem Stahlblech, mit starkem Zentralzapfen verschraubt und gesichert - nachstellbar</p> <p>→ Seite/Page 84</p>	<p>Auswahlhilfe Selection Criteria</p> <table border="0"> <tr> <td>leicht lenkbar/swivels easily</td> <td><input checked="" type="checkbox"/></td> <td><input checked="" type="checkbox"/></td> <td><input checked="" type="checkbox"/></td> </tr> <tr> <td>verschleißarm/wear resistant</td> <td><input checked="" type="checkbox"/></td> <td><input checked="" type="checkbox"/></td> <td><input checked="" type="checkbox"/></td> </tr> <tr> <td>stoßfest/shock proof</td> <td><input checked="" type="checkbox"/></td> <td><input checked="" type="checkbox"/></td> <td><input checked="" type="checkbox"/></td> </tr> <tr> <td>bodenschonend/floor protective</td> <td><input checked="" type="checkbox"/></td> <td><input checked="" type="checkbox"/></td> <td><input checked="" type="checkbox"/></td> </tr> <tr> <td>witterungsbeständig/weather proof</td> <td><input checked="" type="checkbox"/></td> <td><input checked="" type="checkbox"/></td> <td><input checked="" type="checkbox"/></td> </tr> </table>	leicht lenkbar/swivels easily	<input checked="" type="checkbox"/>	<input checked="" type="checkbox"/>	<input checked="" type="checkbox"/>	verschleißarm/wear resistant	<input checked="" type="checkbox"/>	<input checked="" type="checkbox"/>	<input checked="" type="checkbox"/>	stoßfest/shock proof	<input checked="" type="checkbox"/>	<input checked="" type="checkbox"/>	<input checked="" type="checkbox"/>	bodenschonend/floor protective	<input checked="" type="checkbox"/>	<input checked="" type="checkbox"/>	<input checked="" type="checkbox"/>	witterungsbeständig/weather proof	<input checked="" type="checkbox"/>	<input checked="" type="checkbox"/>	<input checked="" type="checkbox"/>
leicht lenkbar/swivels easily	<input checked="" type="checkbox"/>	<input checked="" type="checkbox"/>	<input checked="" type="checkbox"/>																			
verschleißarm/wear resistant	<input checked="" type="checkbox"/>	<input checked="" type="checkbox"/>	<input checked="" type="checkbox"/>																			
stoßfest/shock proof	<input checked="" type="checkbox"/>	<input checked="" type="checkbox"/>	<input checked="" type="checkbox"/>																			
bodenschonend/floor protective	<input checked="" type="checkbox"/>	<input checked="" type="checkbox"/>	<input checked="" type="checkbox"/>																			
witterungsbeständig/weather proof	<input checked="" type="checkbox"/>	<input checked="" type="checkbox"/>	<input checked="" type="checkbox"/>																			

Technische Details

ORDERNO (Artikel-nummer)	PST 125 TLSBAK
WDAB (Rad-Ø A x Breite B / mm)	125x50
LC (Tragkraft / kg)	450
H (Bauhöhe H / mm)	174
TP (Plattengröße / mm)	135x110
HS (Lochabstand / mm)	105x80
HD (Loch-Ø / mm)	12.5
SR (Schwenkradius / mm)	170
WB (Radlager)	Kugellager