

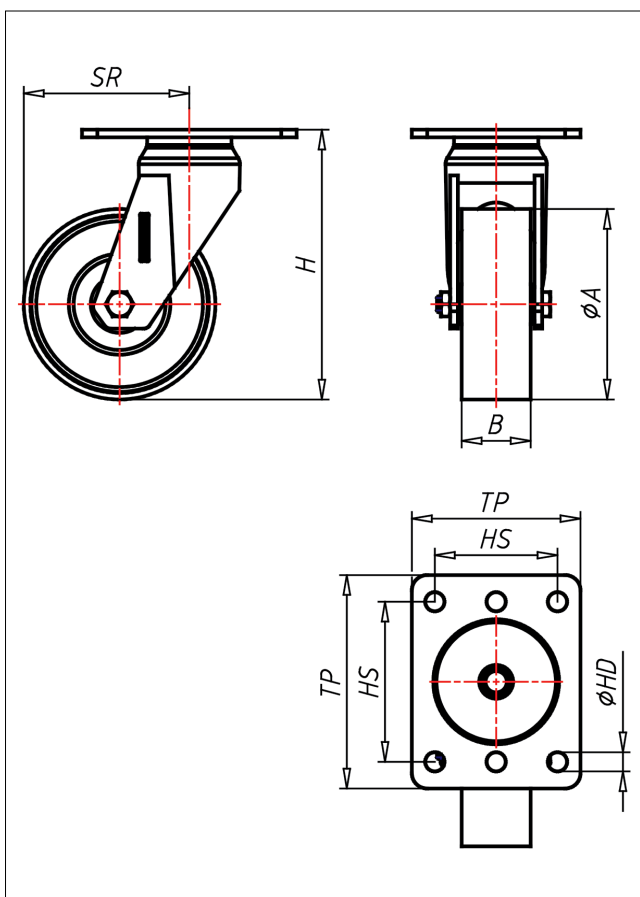

QX-PK/P

Lenkrolle



QX-P



LENKROLLE	LENKROLLE MIT TOTALFESTSTELLER	BOCKROLLE																								
<ul style="list-style-type: none"> • leichter Lauf auf glatten Böden • stoß- und schlagfest • hohe Abriebfestigkeit • leicht zu reinigen • sehr beständig gegen viele aggressive Medien Polyamid 6 - 1. Wahl → Seite 272	zweifaches Kugellager, Edelstahl AISI 304 poliert, starker Zentralbolzen, Radachse verschraubt → Seite 110	AUSWAHLHILFE: <table border="0"> <tr> <td>•</td><td>+</td><td>+</td><td>+</td></tr> <tr> <td>leicht lenkend</td><td>•</td><td>•</td><td>•</td></tr> <tr> <td>verschleißarm</td><td>•</td><td>•</td><td>•</td></tr> <tr> <td>stoßfest</td><td>•</td><td>•</td><td>•</td></tr> <tr> <td>bodenschonend</td><td>•</td><td>•</td><td>•</td></tr> <tr> <td>witterungsbeständig</td><td>•</td><td>•</td><td>•</td></tr> </table>	•	+	+	+	leicht lenkend	•	•	•	verschleißarm	•	•	•	stoßfest	•	•	•	bodenschonend	•	•	•	witterungsbeständig	•	•	•
•	+	+	+																							
leicht lenkend	•	•	•																							
verschleißarm	•	•	•																							
stoßfest	•	•	•																							
bodenschonend	•	•	•																							
witterungsbeständig	•	•	•																							

Technische Details

ORDERNO (Artikel-nummer)	QX 126 PK
WDAB (Rad-Ø A x Breite B / mm)	125x45
LC (Tragkraft / kg)	700
H (Bauhöhe H / mm)	177
TP (Plattengröße / mm)	140x110
HS (Lochabstand / mm)	105x80
HD (Loch-Ø / mm)	12.5
SR (Schwenkradius / mm)	108
WB (Radlager)	Kugellager