

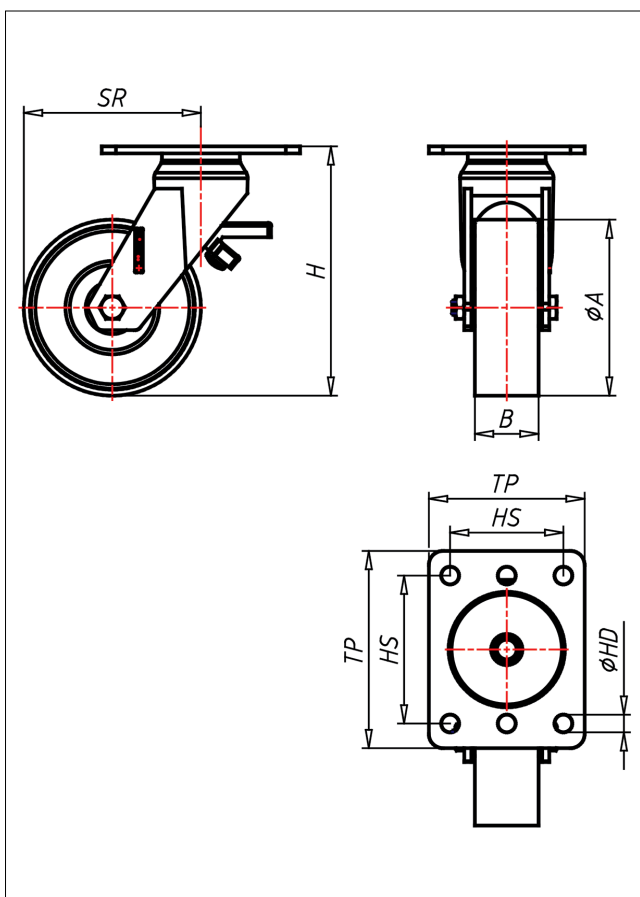

# QXT-PK/P

## Lenkrolle mit Totalfeststeller



QX-P



LENKROLLE	LENKROLLE MIT TOTALFESTSTELLER	BOCKROLLE																								
<ul style="list-style-type: none"> <li>• leichter Lauf auf glatten Böden</li> <li>• stoß- und schlagfest</li> <li>• hohe Abriebfestigkeit</li> <li>• leicht zu reinigen</li> <li>• sehr beständig gegen viele aggressive Medien</li> </ul> Polyamid 6 - 1. Wahl → Seite 272	zweifaches Kugellager, Edelstahl AISI 304 poliert, starker Zentralbolzen, Radachse verschraubt → Seite 110	AUSWAHLHILFE: <table border="0"> <tr> <td>•</td><td>+</td><td>+</td><td>+</td></tr> <tr> <td>leicht lenkend</td><td>•</td><td>•</td><td>•</td></tr> <tr> <td>verschleißarm</td><td>•</td><td>•</td><td>•</td></tr> <tr> <td>stoßfest</td><td>•</td><td>•</td><td>•</td></tr> <tr> <td>bodenschonend</td><td>•</td><td>•</td><td>•</td></tr> <tr> <td>witterungsbeständig</td><td>•</td><td>•</td><td>•</td></tr> </table>	•	+	+	+	leicht lenkend	•	•	•	verschleißarm	•	•	•	stoßfest	•	•	•	bodenschonend	•	•	•	witterungsbeständig	•	•	•
•	+	+	+																							
leicht lenkend	•	•	•																							
verschleißarm	•	•	•																							
stoßfest	•	•	•																							
bodenschonend	•	•	•																							
witterungsbeständig	•	•	•																							

### Technische Details

<b>ORDERNO (Artikel-nummer)</b>	QXT 201 PK
<b>WDAB (Rad-Ø A x Breite B / mm)</b>	200x50
<b>LC (Tragkraft / kg)</b>	1200
<b>H (Bauhöhe H / mm)</b>	250
<b>TP (Plattengröße / mm)</b>	140x110
<b>HS (Lochabstand / mm)</b>	105x80
<b>HD (Loch-Ø / mm)</b>	12.5
<b>SR (Schwenkradius / mm)</b>	158
<b>WB (Radlager)</b>	Kugellager