

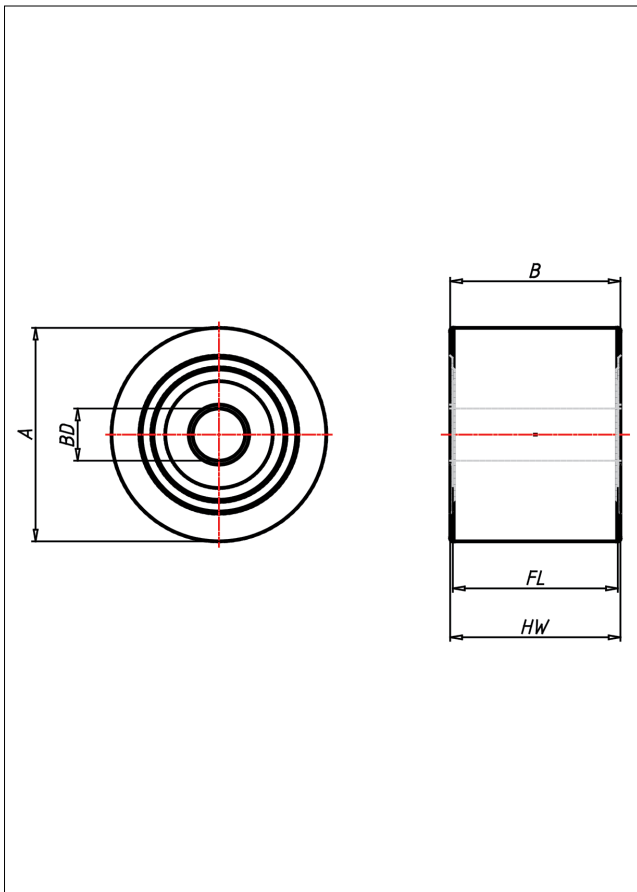

# RZ Rad

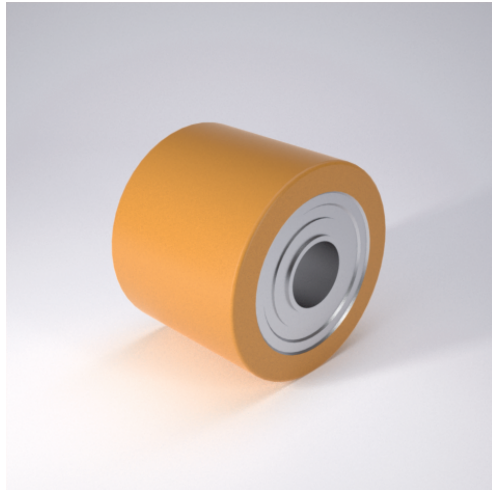

RZ



+80 °C  
-20 °C  
max. 1000 kg

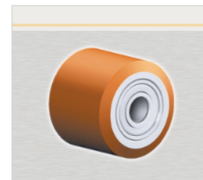

Radkörper aus Stahl  
Laufbelag aus Guss-Polyurethan, 95±3 Shore A

- geräuscharmer Lauf
- geringer Rollwiderstand
- abrieb- und reifest
- hohe Stofestigkeit
- sehr bestndig gegen viele aggressive Medien

## Technische Details

<b>ORDERNO (Artikel-nummer)</b>	RZ 80x50 K20
<b>WDAB (Rad-Ø A x Breite B / mm)</b>	80x50
<b>LC (Tragkraft / kg)</b>	460
<b>HW (Nabellnge / mm)</b>	50
<b>FL (Einbaulnge / mm)</b>	50
<b>WB (Radlager)</b>	2 Rillen-Kugellager 6204 ZZ
<b>BD (Bohrungsdurchmesser / mm)</b>	20