

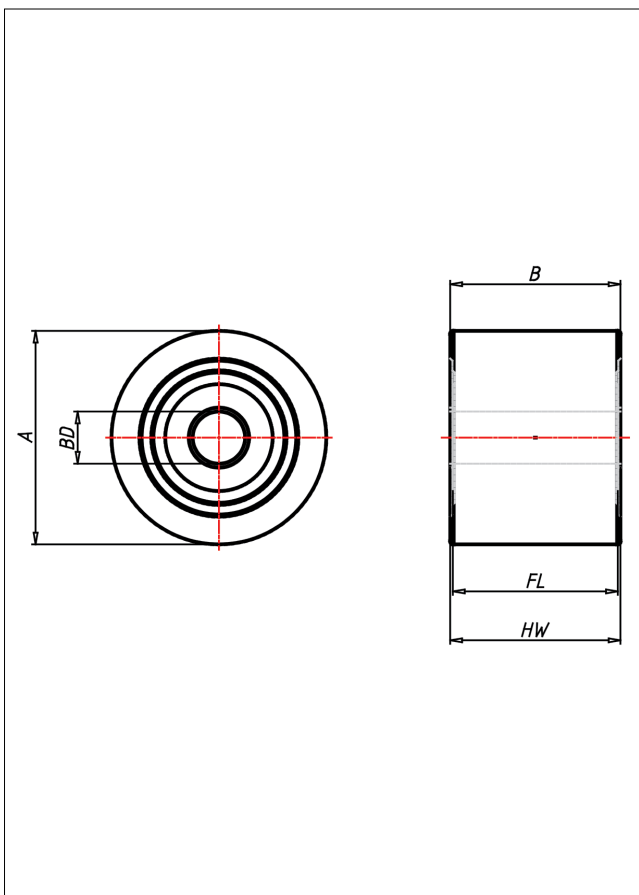

RZ
Rad

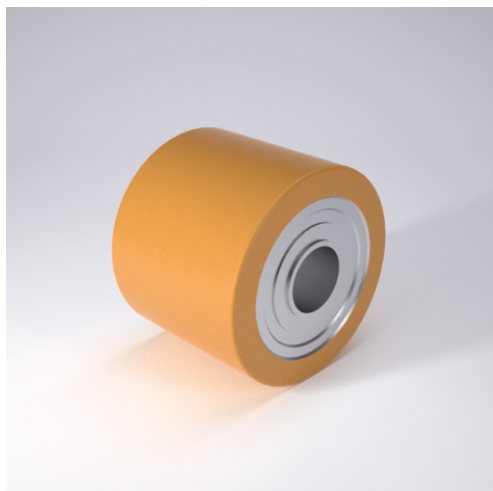

RZ

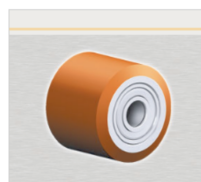

Radkörper aus Stahl
Laufbelag aus Guss-Polyurethan, 95±3 Shore A

- geräuscharmer Lauf
- geringer Rollwiderstand
- abrieb- und reißfest
- hohe Stoßfestigkeit
- sehr beständig gegen viele aggressive Medien

Technische Details

ORDERNO (Artikel-nummer)	RZ 82x70 K25
WDAB (Rad-Ø A x Breite B / mm)	82x70
LC (Tragkraft / kg)	650
HW (Nabellänge / mm)	70
FL (Einbaulänge / mm)	62
WB (Radlager)	2 Rillen-Kugellager 6005 ZZ
BD (Bohrungsdurchmesser / mm)	25