

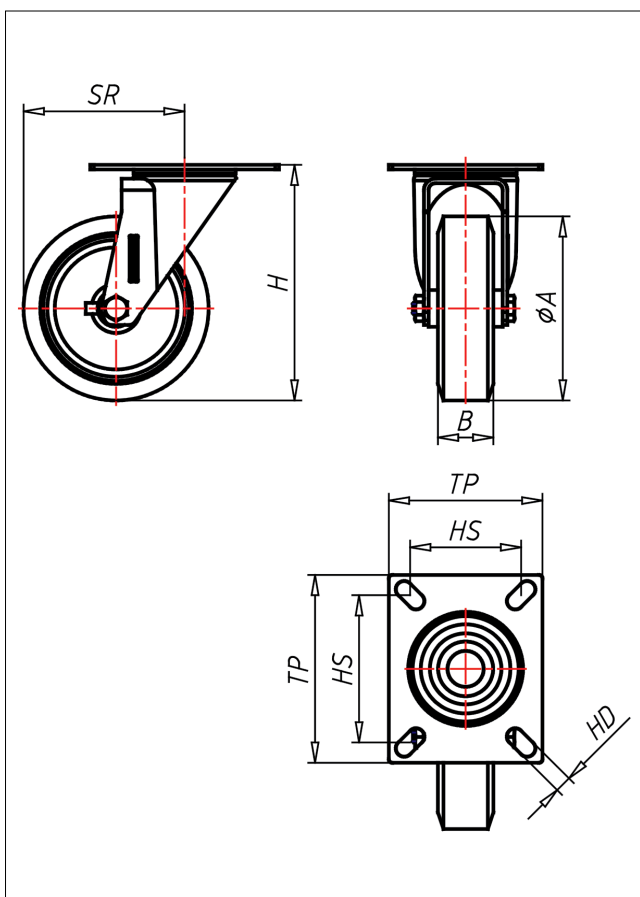

XD/XS/XSS/XL-A/ABX

Lenkrolle



XD-A



LENKROLLE	LENKROLLE MIT TOTALFESTSTELLER	BOCKROLLE																		
<ul style="list-style-type: none"> geräuscharmer Lauf geringer Rollwiderstand abrieb- und reißfest hohe Stoßfestigkeit leichte Reinigung sehr beständig gegen viele aggressive Medien <p>Guss-Polyurethan Felge Polyamid 6 → Seite 252</p>	<p>zweifaches Kugellager - vernietet Edelstahl AISI 304 poliert, Laufkugeln AISI 420, Staubschutzring, Radachse verschraubt</p> <p>→ Seite 110</p>	<p>AUSWAHLHILFE:</p> <table border="0"> <tr> <td>-</td><td>+</td><td>++</td> </tr> <tr> <td>leicht lenkend</td><td>X</td><td></td> </tr> <tr> <td>verschleißarm</td><td></td><td>X</td> </tr> <tr> <td>stoßfest</td><td></td><td>X</td> </tr> <tr> <td>bodenschonend</td><td></td><td>X</td> </tr> <tr> <td>witterungsbeständig</td><td></td><td>X</td> </tr> </table>	-	+	++	leicht lenkend	X		verschleißarm		X	stoßfest		X	bodenschonend		X	witterungsbeständig		X
-	+	++																		
leicht lenkend	X																			
verschleißarm		X																		
stoßfest		X																		
bodenschonend		X																		
witterungsbeständig		X																		

Technische Details

ORDERNO (Artikel-nummer)	XD 150 A
WDAB (Rad-Ø A x Breite B / mm)	150x40
LC (Tragkraft / kg)	250
H (Bauhöhe H / mm)	181
TP (Plattengröße / mm)	135x110
HS (Lochabstand / mm)	105x80
HD (Loch-Ø / mm)	11
SR (Schwenkradius / mm)	126
WB (Radlager)	Polyamid-Gleitlager