

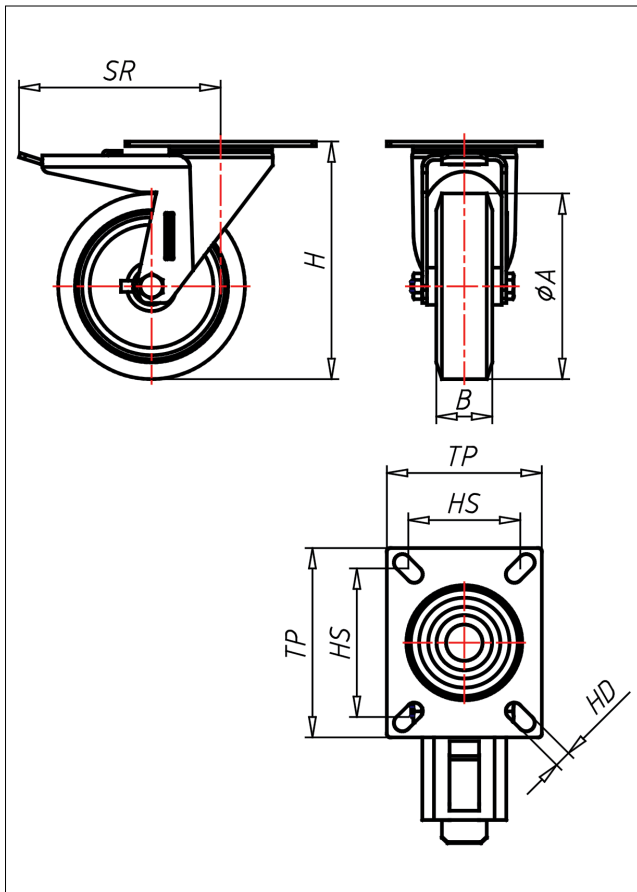

XDT/XST/XSST/XLT-A/ABX

Lenkrolle mit Totalfeststeller



XD-A



LENKROLLE	LENKROLLE MIT TOTALFESTSTELLER	BOCKROLLE																		
<ul style="list-style-type: none"> • geräuscharmer Lauf • geringer Rollwiderstand • abrieb- und reißfest • hohe Stoßfestigkeit • leichte Reinigung • sehr beständig gegen viele aggressive Medien <p>Guss-Polyurethan Felge Polyamid 6 → Seite 252</p>	<p></p> <p>zweifaches Kugellager - vernietet Edelstahl AISI 304 poliert, Laufkugeln AISI 420, Staubschutzring, Radachse verschraubt</p> <p>→ Seite 110</p>	<p>AUSWAHLHILFE:</p> <table border="0"> <tr> <td>-</td> <td>+</td> <td>++</td> </tr> <tr> <td>leicht lenkend</td> <td>X</td> <td>X</td> </tr> <tr> <td>verschleißarm</td> <td>○</td> <td>X</td> </tr> <tr> <td>stoßfest</td> <td>○</td> <td>X</td> </tr> <tr> <td>bodenschonend</td> <td>○</td> <td>X</td> </tr> <tr> <td>witterungsbeständig</td> <td>○</td> <td>X</td> </tr> </table>	-	+	++	leicht lenkend	X	X	verschleißarm	○	X	stoßfest	○	X	bodenschonend	○	X	witterungsbeständig	○	X
-	+	++																		
leicht lenkend	X	X																		
verschleißarm	○	X																		
stoßfest	○	X																		
bodenschonend	○	X																		
witterungsbeständig	○	X																		

Technische Details

ORDERNO (Artikel-nummer)	XDT 125 ABX
WDAB (Rad-Ø A x Breite B / mm)	125x30
LC (Tragkraft / kg)	150
H (Bauhöhe H / mm)	154
TP (Plattengröße / mm)	102x83
HS (Lochabstand / mm)	80x60
HD (Loch-Ø / mm)	9
SR (Schwenkradius / mm)	108
WB (Radlager)	Rollenlager