

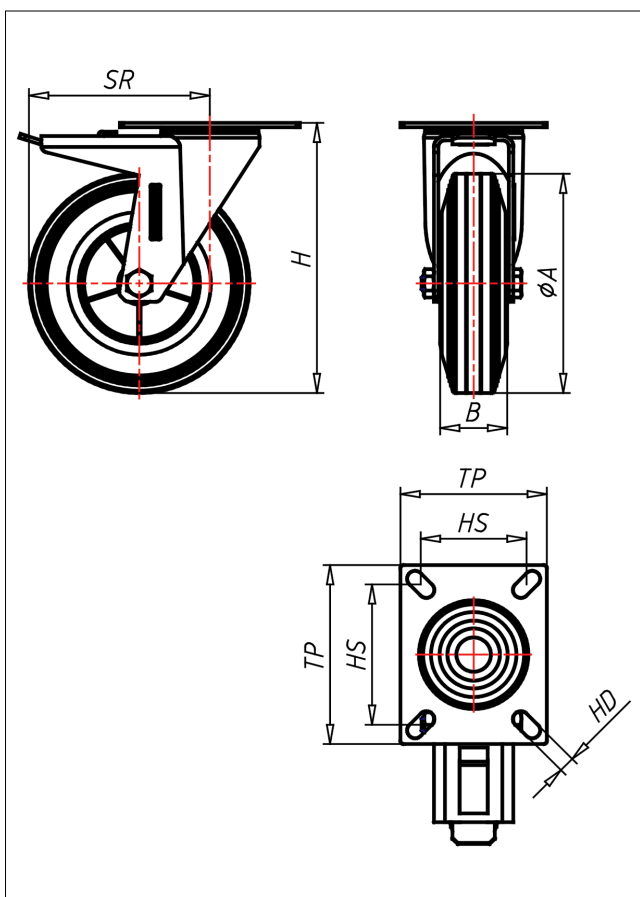

XDT/XLT-DGBX/DG

Lenkrolle mit Totalfeststeller



XD-DG



LENKROLLE	LENKROLLE MIT TOTALFESTSTELLER	BOCKROLLE																		
 <ul style="list-style-type: none"> • spurfrei - bodenschonend • hoher Fahrkomfort • sehr laufruhig • geringer Rollwiderstand • abriebfest <p>ELASTIK-Vollgummi Felge Kunststoff → Seite 202</p> 	 <p>zweifaches Kugellager - vernietet, Edelstahl AISI 304 poliert, Laufkugeln AISI 420, Staubschutzring, Radachse verschraubt → Seite 110</p>	 <p>AUSWAHLHILFE:</p> <table border="0"> <tr> <td>-</td> <td>+</td> <td>++</td> </tr> <tr> <td>leicht lenkend</td> <td>X</td> <td>●</td> </tr> <tr> <td>verschleißarm</td> <td>●</td> <td>X</td> </tr> <tr> <td>stoßfest</td> <td>●</td> <td>X</td> </tr> <tr> <td>bodenschonend</td> <td>●</td> <td>X</td> </tr> <tr> <td>witterungsbeständig</td> <td>●</td> <td>X</td> </tr> </table>	-	+	++	leicht lenkend	X	●	verschleißarm	●	X	stoßfest	●	X	bodenschonend	●	X	witterungsbeständig	●	X
-	+	++																		
leicht lenkend	X	●																		
verschleißarm	●	X																		
stoßfest	●	X																		
bodenschonend	●	X																		
witterungsbeständig	●	X																		

Technische Details

ORDERNO (Artikel-nummer)	XDT 125 DG
WDAB (Rad-Ø A x Breite B / mm)	125x38
LC (Tragkraft / kg)	110
H (Bauhöhe H / mm)	154
TP (Plattengröße / mm)	102x83
HS (Lochabstand / mm)	80x60
HD (Loch-Ø / mm)	9
SR (Schwenkradius / mm)	108
WB (Radlager)	Polyamid-Gleitlager