

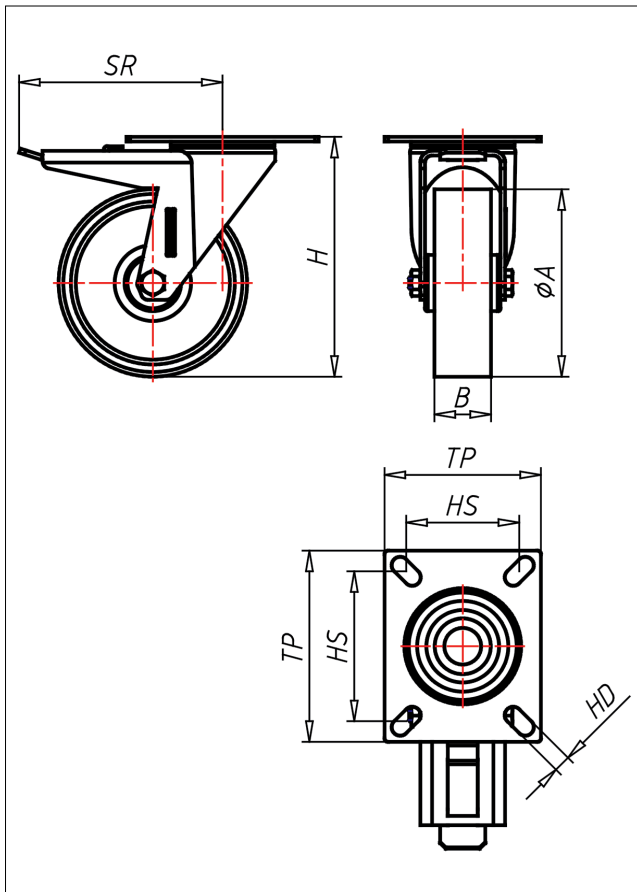

XDT/XST/XSST/XLT-AL/ALBX

Lenkrolle mit Totalfeststeller



XD-AL



LENKROLLE	LENKROLLE MIT TOTALFESTSTELLER	BOCKROLLE																		
<ul style="list-style-type: none"> • geringer Rollwiderstand • abrieb- und reißfest • leichte Reinigung • sehr beständig gegen viele aggressive Medien Spritzguss-Polyurethan Felge Polyamid 6 → Seite 233	zweifaches Kugellager - vernietet, Edelstahl AISI 304 poliert, Laufkugeln AISI 420, Staubschutzring, Radachse verschraubt → Seite 110	AUSWAHLHILFE: <table border="0"> <tr> <td>-</td><td>+</td><td>++</td></tr> <tr> <td>leicht lenkend</td><td>X</td><td>●</td></tr> <tr> <td>verschleißarm</td><td>●</td><td>●</td></tr> <tr> <td>stoßfest</td><td>X</td><td>●</td></tr> <tr> <td>bodenschonend</td><td>●</td><td>●</td></tr> <tr> <td>witterungsbeständig</td><td>●</td><td>●</td></tr> </table>	-	+	++	leicht lenkend	X	●	verschleißarm	●	●	stoßfest	X	●	bodenschonend	●	●	witterungsbeständig	●	●
-	+	++																		
leicht lenkend	X	●																		
verschleißarm	●	●																		
stoßfest	X	●																		
bodenschonend	●	●																		
witterungsbeständig	●	●																		

Technische Details

ORDERNO (Artikel-nummer)	XDT 80 AL
WDAB (Rad-Ø A x Breite B / mm)	80x25
LC (Tragkraft / kg)	100
H (Bauhöhe H / mm)	106
TP (Plattengröße / mm)	102x83
HS (Lochabstand / mm)	80x60
HD (Loch-Ø / mm)	9
SR (Schwenkradius / mm)	108
WB (Radlager)	Polyamid-Gleitlager