

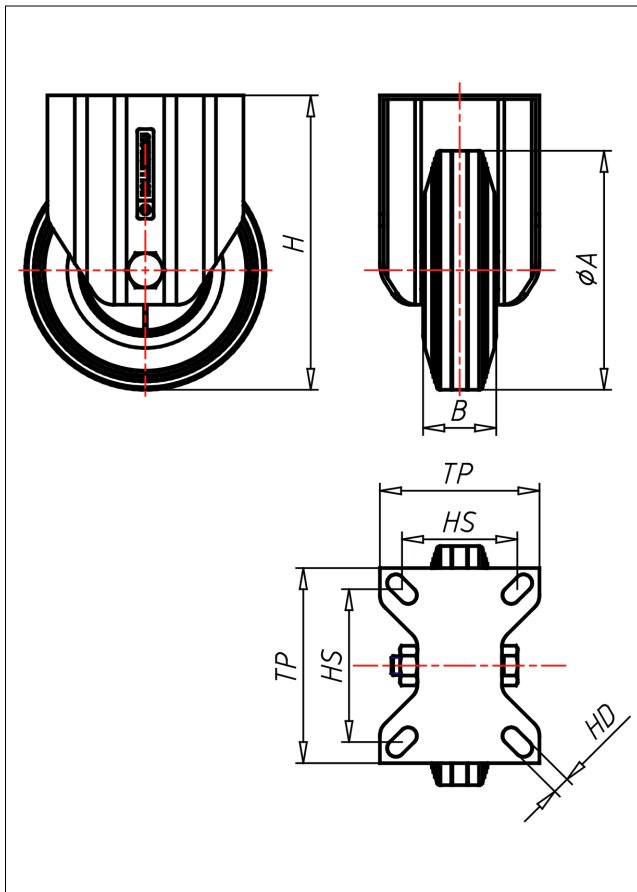

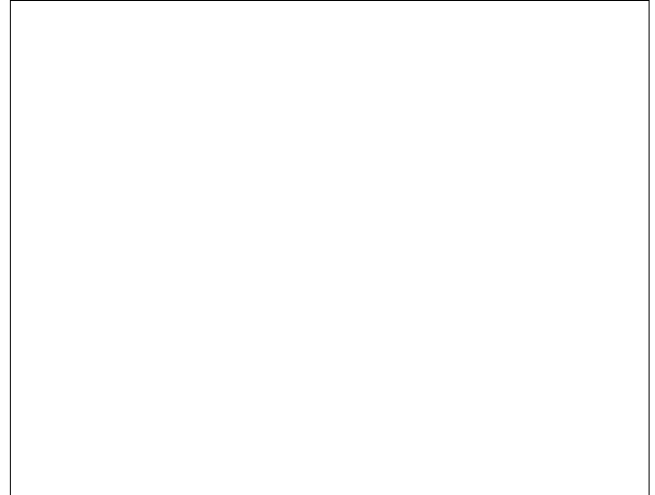

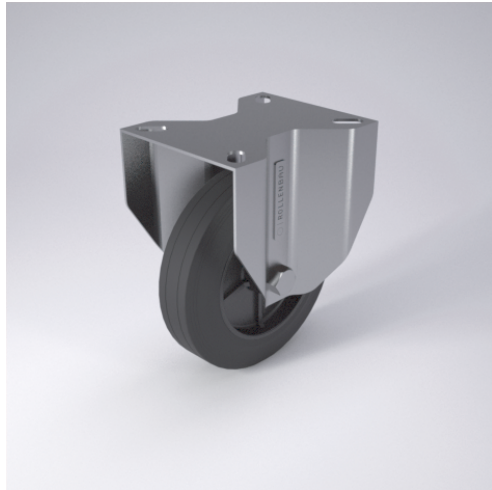



XF/XLF-D

Bockrolle



XD-D



LENKROLLE	LENKROLLE MIT TOTALFESTSTELLER	BOCKROLLE																		
 <ul style="list-style-type: none"> geräuscharmer Lauf großer Fahrkomfort beständig gegen verdünnte Säuren <p>Vollgummi schwarz Felge Kunststoff schwarz → Seite 265</p> 	  <p>zweifaches Kugellager - vernietet, Edelstahl ANSI 304 poliert, Laufkugeln ANSI 420, Staubschutzring, Radachse verschraubt → Seite 110</p>	 <p>AUSWAHLHILFE:</p> <table border="0"> <tr> <td>-</td> <td>+</td> <td>++</td> </tr> <tr> <td>leicht lenkend</td> <td>x</td> <td>x</td> </tr> <tr> <td>verschleißarm</td> <td>x</td> <td>x</td> </tr> <tr> <td>stoßfest</td> <td>x</td> <td>x</td> </tr> <tr> <td>bodenschonend</td> <td>x</td> <td>x</td> </tr> <tr> <td>witterungsbeständig</td> <td>x</td> <td>x</td> </tr> </table>	-	+	++	leicht lenkend	x	x	verschleißarm	x	x	stoßfest	x	x	bodenschonend	x	x	witterungsbeständig	x	x
-	+	++																		
leicht lenkend	x	x																		
verschleißarm	x	x																		
stoßfest	x	x																		
bodenschonend	x	x																		
witterungsbeständig	x	x																		

Technische Details

ORDERNO (Artikel-nummer)	XF 150 D
WDAB (Rad-Ø A x Breite B / mm)	150x40
LC (Tragkraft / kg)	125
H (Bauhöhe H / mm)	181
TP (Plattengröße / mm)	135x110
HS (Lochabstand / mm)	105x80
HD (Loch-Ø / mm)	11
WB (Radlager)	Polyamid-Gleitlager