

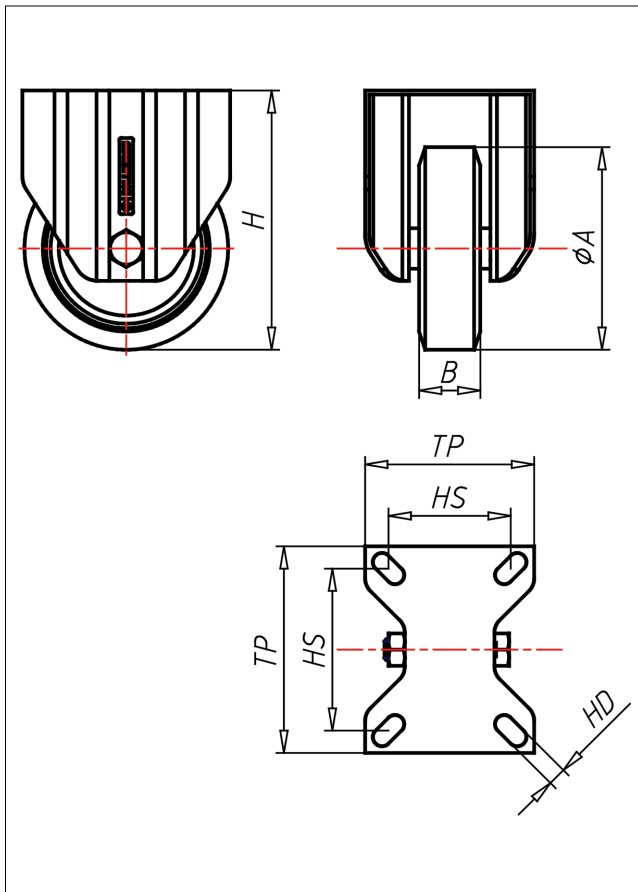

XF/XSF/XSSF/XLF- A/ABX Bockrolle

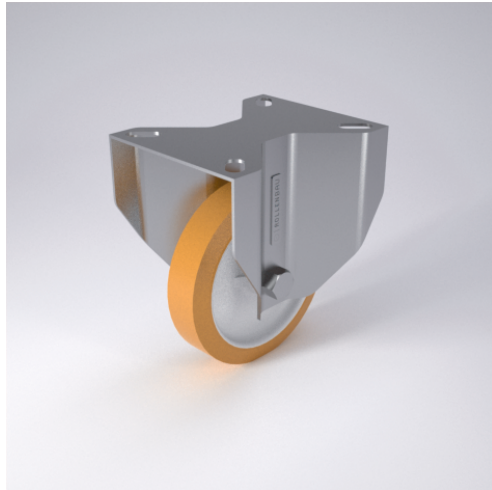

XD-A



LENKROLLE	LENKROLLE MIT TOTALFESTSTELLER	BOCKROLLE
<ul style="list-style-type: none"> • geräuscharmer Lauf • geringer Rollwiderstand • abrieb- und reißfest • hohe Stoßfestigkeit • leichte Reinigung • sehr beständig gegen viele aggressive Medien <p>Guss-Polyurethan Felge Polyamid 6 → Seite 252</p>	<p>zweifaches Kugellager - vernietet Edelstahl AISI 304 poliert, Laufkugeln AISI 420, Staubschutzring, Radachse verschraubt</p> <p>→ Seite 110</p>	<p>AUSWAHLHILFE:</p> <ul style="list-style-type: none"> leicht lenkend <input checked="" type="checkbox"/> verschleißarm <input checked="" type="checkbox"/> stoßfest <input checked="" type="checkbox"/> bodenschonend <input checked="" type="checkbox"/> witterungsbeständig <input checked="" type="checkbox"/>

Technische Details

ORDERNO (Artikel-nummer)	XF 175 A
WDAB (Rad-Ø A x Breite B / mm)	175x40
LC (Tragkraft / kg)	370
H (Bauhöhe H / mm)	216
TP (Plattengröße / mm)	135x110
HS (Lochabstand / mm)	105x80
HD (Loch-Ø / mm)	11
WB (Radlager)	Polyamid-Gleitlager