

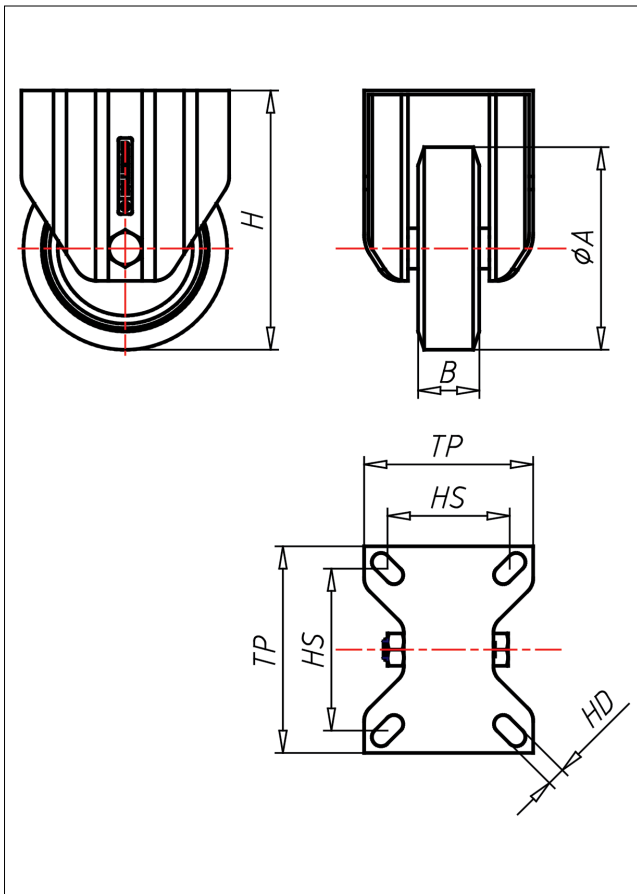

# XF/XSF/XSSF/XLF- A/ABX Bockrolle

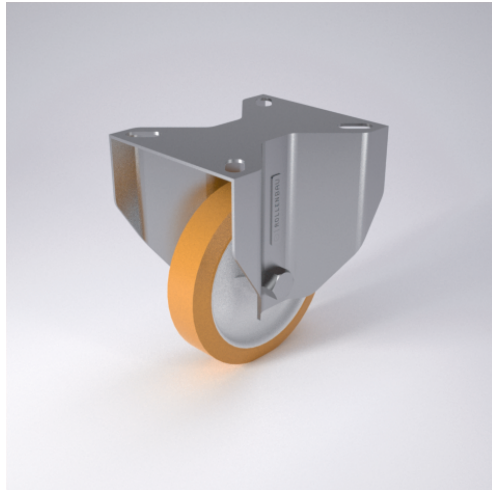

XD-A



LENKROLLE	LENKROLLE MIT TOTALFESTSTELLER	BOCKROLLE																		
<ul style="list-style-type: none"> <li>• geräuscharmer Lauf</li> <li>• geringer Rollwiderstand</li> <li>• abrieb- und reißfest</li> <li>• hohe Stoßfestigkeit</li> <li>• leichte Reinigung</li> <li>• sehr beständig gegen viele aggressive Medien</li> </ul> <p>Guss-Polyurethan Felge Polyamid 6 → Seite 252</p> 	<p>zweifaches Kugellager - vernietet Edelstahl AISI 304 poliert, Laufkugeln AISI 420, Staubschutzring, Radachse verschraubt</p> <p>→ Seite 110</p>	<p>AUSWAHLHILFE:</p> <table border="0"> <tr> <td>•</td> <td>+</td> <td>++</td> </tr> <tr> <td>leicht lenkend</td> <td>X</td> <td>X</td> </tr> <tr> <td>verschleißarm</td> <td>•</td> <td>X</td> </tr> <tr> <td>stoßfest</td> <td>•</td> <td>X</td> </tr> <tr> <td>bodenschonend</td> <td>•</td> <td>X</td> </tr> <tr> <td>witterungsbeständig</td> <td>•</td> <td>X</td> </tr> </table>	•	+	++	leicht lenkend	X	X	verschleißarm	•	X	stoßfest	•	X	bodenschonend	•	X	witterungsbeständig	•	X
•	+	++																		
leicht lenkend	X	X																		
verschleißarm	•	X																		
stoßfest	•	X																		
bodenschonend	•	X																		
witterungsbeständig	•	X																		

## Technische Details

<b>ORDERNO (Artikel-nummer)</b>	XF 80 A
<b>WDAB (Rad-Ø A x Breite B / mm)</b>	80X24
<b>LC (Tragkraft / kg)</b>	120
<b>H (Bauhöhe H / mm)</b>	106
<b>TP (Plattengröße / mm)</b>	102x83
<b>HS (Lochabstand / mm)</b>	80x60
<b>HD (Loch-Ø / mm)</b>	9
<b>WB (Radlager)</b>	Polyamid-Gleitlager